

MITSUBISHI

10/100/1000M

Industrial Switching HUB

NZ2EHG-T8

User's Manual

Powered by CONTEC

This product was jointly developed and manufactured by Mitsubishi and CONTEC.

Note that some of the warranty on this product differs from that on other products (MELSEC-Q or MELSEC-L series).
(Refer to "Terms of Warranty".)

MODEL	NZ2EHG-T8-U
MODEL CODE	13J246
IB(NA)-0800460-C(1007)MEE	

Precautions regarding Warranty and Specifications

This product was jointly developed and manufactured by Mitsubishi and CONTEC.

Note that there are some precautions regarding warranty and specifications of the product.

<Warranty>

- The gratis warranty term of the product shall be for one (1) year after the date of delivery or for eighteen (18) months after manufacturing, whichever is less.
- The onerous repair term after discontinuation of production shall be for six (6) years.
- Mitsubishi shall mainly replace products that need repair.
- It may take some time to respond to the problem or repair the product depending on the condition and timing.

<Specifications>

- General specifications are different.

	NZ2EHG-T8	MELSEC-Q Series
Operating ambient temperature	0 to 50°C	0 to 55°C
Operating ambient humidity	10 to 90%RH	5 to 95%RH
Storage ambient temperature	-10 to 60°C	-25 to 75°C
Storage ambient humidity	10 to 90%RH	5 to 95%RH

- EMC standards that are applicable to the products differ.



	NZ2EHG-T8	MELSEC-Q Series
EMC standards	EN55022, EN55024, EN61000-6-2	EN61131-2

Safety Precautions

Review the following definitions and precautions to use the product safely.

Safety Information

This document provides safety information using the following symbols to prevent accidents resulting in injury or death and the destruction of equipment and resources. Review the meanings of these labels to operate the equipment safely.

 WARNING	WARNING indicates a potentially hazardous situation which, if not avoided, could result in death or serious injury.
 CAUTION	CAUTION indicates a potentially hazardous situation which, if not avoided, may result in minor or moderate injury or in property damage.

Handling Precautions

WARNING

- Do not use the product where it is exposed to flammable or corrosive gas. Failure to do so may result in an explosion, fire, electric shock, or failure.
- The product could be very hot in the operation. Please do not touch with hands or body. It may cause burns.
- To avoid electric shock, please do not touch the system with a wet hand.

CAUTION

- The link speed value (e.g., 1000Mbps) of the transmission rate used in this manual is the theoretical maximum value of the wired LAN standard and does not indicate the actual data transmission speed.
- Frame loss could occur depending on the connection destination or installed environment.
- When attempt is made to perform communication for devices that are not Jumbo Frame compatible, communication efficiency may drop extremely. There are also cases where communication is disconnected.
- As this product contains precision electronic components, do not use or store it in a place subject to shock or vibration. Doing so may cause malfunction, heat generation, fault, or damage.
- Ground the FG terminal to a protective ground conductor.
- Place the cables in a duct or clamp them. If not, dangling cable may swing or inadvertently be pulled, resulting in damage to the module or cables or malfunction due to poor contact.
- When disconnecting the communication cable or power cable from the module, do not pull the cable by the cable part.
- Correctly connect the power cables to the HUB unit.
- Do not install control lines or communication cables together with the main circuit lines or power cables. Keep a distance of 100mm or more between them. Failure to do so may result in malfunction due to noise.
- Prevent foreign matter such as dust or wire chips from entering the module. Such foreign matter can cause a fire, failure, or malfunction.

-
- Do not use or store the product in a hot or cold place, or in a place that is subject to severe temperature changes. Doing so may cause malfunction, heat generation, fault, or damage.
 - Do not use or store the product in a place subject to direct sunlight or near a heating device, such as a stove. And do not use or store the product near equipment generating a strong magnetic field or radio waves. Doing so may cause malfunction, heat generation, fault, or damage.
 - Do not use or store this product in the presence of chemicals.
 - Do not use this product in extremely humid or dusty locations. It is extremely dangerous to use this product in locations where water, other fluid, or conductive dust may enter the interior of the unit. To use this product in such an environment, install it in a dust-proof control panel, for example.
 - If you notice abnormal odor or overheating, please disconnect the power cable immediately.
 - If you find a fault or other abnormality (bad smell or excessive heat), unplug the power terminal connector and then contact the distributor.
 - Do not open the product casing. Mitsubishi will disclaim any responsibility for products whose casing has been opened.
 - Do not modify the product. Mitsubishi will bear no responsibility for any problems, etc., resulting from modifying the product.
 - To clean this product, gently wipe it with a soft cloth soaked with water or a neutral detergent. Do not use benzene, paint thinner, or other volatile solvents as they can cause the coating to discolor or peel off.
 - The specifications of this product are subject to change without notice because of function addition and quality improvement.
Even when using the product continuously, read the user's manual and check the contents.
 - If you move or transfer the product, make sure to provide this manual with the product.
 - Regardless of the foregoing statements, Mitsubishi is not liable for any damages whatsoever (including damages for loss of business profits) arising out of the use or inability to use this Mitsubishi product or the information contained herein.
-

FCC PART15 class A Notice

NOTE

This equipment has been tested and found to comply with the limits for a Class A digital device, pursuant to part 15 of the FCC Rules. These limits are designed to provide reasonable protection against harmful interference when the equipment is operated in commercial environment.

This equipment generates, uses, and can radiate radio frequency energy and, if not installed and used in accordance with the instruction manual, may cause harmful interference to radio communications. Operation of this equipment in a residential area is likely to cause harmful interference at his own expense.

WARNING TO USER

Change or modifications not expressly approved the manufacturer can void the user's authority to operate this equipment.

CONDITIONS OF USE FOR THE PRODUCT

- (1) Mitsubishi programmable controller ("the PRODUCT") shall be used in conditions;
 - i) where any problem, fault or failure occurring in the PRODUCT, if any, shall not lead to any major or serious accident; and
 - ii) where the backup and fail-safe function are systematically or automatically provided outside of the PRODUCT for the case of any problem, fault or failure occurring in the PRODUCT.
- (2) The PRODUCT has been designed and manufactured for the purpose of being used in general industries.

MITSUBISHI SHALL HAVE NO RESPONSIBILITY OR LIABILITY (INCLUDING, BUT NOT LIMITED TO ANY AND ALL RESPONSIBILITY OR LIABILITY BASED ON CONTRACT, WARRANTY, TORT, PRODUCT LIABILITY) FOR ANY INJURY OR DEATH TO PERSONS OR LOSS OR DAMAGE TO PROPERTY CAUSED BY the PRODUCT THAT ARE OPERATED OR USED IN APPLICATION NOT INTENDED OR EXCLUDED BY INSTRUCTIONS, PRECAUTIONS, OR WARNING CONTAINED IN MITSUBISHI'S USER, INSTRUCTION AND/OR SAFETY MANUALS, TECHNICAL BULLETINS AND GUIDELINES FOR the PRODUCT.

("Prohibited Application")

Prohibited Applications include, but not limited to, the use of the PRODUCT in;

- Nuclear Power Plants and any other power plants operated by Power companies, and/or any other cases in which the public could be affected if any problem or fault occurs in the PRODUCT.
- Railway companies or Public service purposes, and/or any other cases in which establishment of a special quality assurance system is required by the Purchaser or End User.
- Aircraft or Aerospace, Medical applications, Train equipment, transport equipment such as Elevator and Escalator, Incineration and Fuel devices, Vehicles, Manned transportation, Equipment for Recreation and Amusement, and Safety devices, handling of Nuclear or Hazardous Materials or Chemicals, Mining and Drilling, and/or other applications where there is a significant risk of injury to the public or property.

Packing List

Thank you for purchasing this Mitsubishi product. The product package contains the items listed below. Check the contents of the product package. If you discover any damaged or missing items, contact the distributor.

Contents

Name	Pcs.
Industrial switching HUB unit (NZ2EHG-T8)	1
User's Manual	1
Power terminal connector	1
Retention bracket	1
Mounting bracket	2
Bracket screw M3x6	5

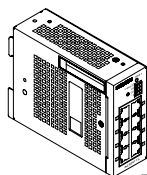

Unit



Power terminal connector



Retention bracket

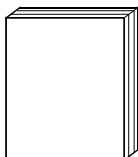

User's Manual

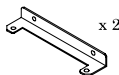

Mounting bracket



Bracket screw

CAUTION

To operate this product, a power supply (12-24VDC±5%) is required separately. For power supply, see Chapter 2, Part Names and Settings, "Power Supply".

- This document, in whole or in part, may not be reproduced without permission.
- This document is subject to change without notice at any time.
- While we are doing our best to ensure this document has no error, should you have any questions or find any omissions or similar, consult the distributor.

Table of Contents

Packing List	5
1. Before Using the Product	7
About the Unit	7
Features	7
Environment	8
Inspection	8
Storage	8
Disposal	8
2. Part Names and Settings	9
Part Names and Functions	9
3. Setup of Hardware	11
Mounting/Removing a Unit on/from a DIN Rail	11
Mounting Procedure	11
Removing Procedure	12
Attaching mounting brackets	14
Attachment	14
Attaching a retention bracket	15
Attachment	15
Installation Conditions	16
Installation Orientation	16
Spacing between Unit and Surrounding Objects	18
4. Connecting to a Network	20
Network Cables	20
Connecting to Programmable Controllers, Personal Computers, Additional HUB Units, or Bridges	20
Connection Restrictions for 100BASE-TX Repeater HUBs	21
Connection Restrictions for 10BASE-T Repeater HUBs	21
5. System Reference	22
Specifications	22
External Dimensions	24
EMC Directive	25

1. Before Using the Product

This chapter provides information you should know before using the product.

About the Unit

NZ2EHG-T8 is a compact-sized [39(W)×120(D)×94(H)mm] industrial switching HUB unit that is compliant with the IEEE802.3ab (1000BASE-T)/IEEE802.3u (100BASE-TX)/IEEE802.3 (10BASE-T) standards.

Its features include Jumbo Frame support, AutoMDI/MDI-X, auto-negotiation, and automatic power adjusting function. The automatic power adjusting function can reduce the power consumption by up to 80%. *1

With fan less configuration, NZ2EHG-T8 is suitable for places where silence is required. In addition, the adoption of metal casing with great radiation performance enables the unit to be used in ambient temperatures of 0 to 50°C. A DIN rail mounting mechanism and the mounting brackets provided with the unit enable various types of installation.

Please read this manual carefully so that you can build a system by connecting the switching HUB unit to external devices.

Features

- Compact-sized (39 (W) × 120 (D) × 94 (H) mm) unit equipped with 8 ports capable of 1000BASE-T
The compact-sized unit enclosure (39 (W) × 120 (D) × 94 (H) mm) is equipped with the 8 ports that are compliant with IEEE802.3ab (1000BASE-T)/IEEE802.3u (100BASE-TX)/IEEE802.3 (10BASE-T). With fan less configuration, this product is suitable for places where silence is required. In addition, the adoption of metal casing with great radiation performance provides the operating ambient temperature of 0 to 50°C.
- Auto MDI/MDI-X feature, auto-negotiation feature
The Auto MDI/MDI-X feature can automatically recognize the cable type, straight-through cable or crossover cable, to prevent problems using the wrong cable type.
Also, the auto-negotiation feature can automatically recognize and choose the best communication rate (10/100/1000Mbps) and method (half/full duplex) available.
- Automatic power adjusting function
This function can automatically adjust the power consumption of unused ports, enabling reduced power consumption by up to 80%. *1
- Flexible installation orientation.
The unit is equipped with a 35mm DIN rail mounting mechanism as standard. Also, the mounting brackets provided with the unit make installation in any orientation possible (floor, ceiling, etc.).
- Capable of running on a wide range of input voltages (12 to 24VDC)
The unit will function normally even if input voltage fluctuates within the acceptable range. In addition, the power connector includes an FG terminal.

*1 The comparison result of measured values when all (eight) ports are in operation with those when all (eight) ports are unused.

Environment

Use this product in the following environment. If used under environmental conditions exceeding these ranges, the board may overheat, malfunction, or cause a failure.

Operating temperature

0 to 50°C

Operating humidity

10 to 90%RH (No condensation)

Corrosive gases

None

Floating dust particles

Small amounts (non excessive)

Inspection

Inspect the product periodically as follows to use it safely.

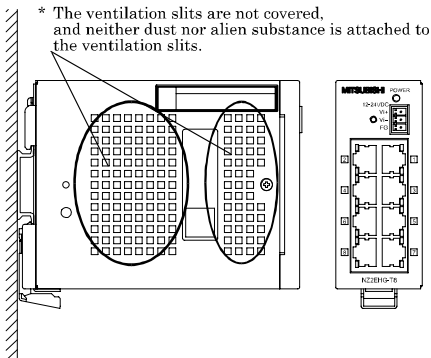

Storage

When storing this product, keep it in its original packing form.

- (1) Put the unit in the storage bag.
- (2) Wrap it in the packing material, then put it in the box.
- (3) Store the package at room temperature at a place free from direct sunlight, moisture, shock, vibration, magnetism, and static electricity.

Disposal

When disposing of the product, follow the disposal procedures stipulated under the relevant laws and municipal ordinances.

2. Part Names and Settings

Part Names and Functions

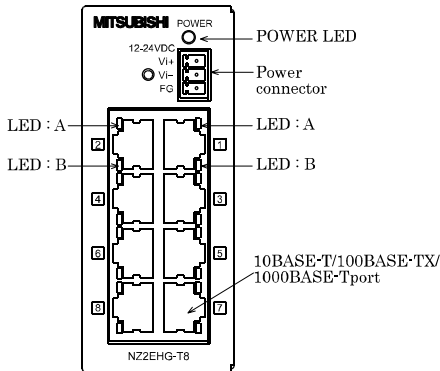

Figure 2.1. Part names

Table 2.1. LED indicators

Name	Status	Color	Display
POWER LED	POWER	Green	OFF : Power off ON : Power on
LED:A	10Mbps 100Mbps	Yellow Green	OFF : No LINK ON : LINK
LED:B	1000Mbps	Green	Flashing : ACT (Data send/receive)

Table 2.2. Connectors

Name	Function																											
Power connector	<p>Power terminal connector (included in the package): MC1,5/3-ST-3,5 (made by Phoenix Contact Inc.) The applicable cable is AWG28-16. (The cable length must meet the power supply specifications.) Secure the connector with a retention bracket. Connect the power cable to the power terminal connector by screw connection. The fastening torque range is 0.22 to 0.25Nm.</p> <table border="1"> <thead> <tr> <th>Power connector</th> <th colspan="2">MC1,5/3-G-3,5 (Phoenix Contact)</th> </tr> </thead> <tbody> <tr> <td colspan="3" style="text-align: center;">12-24VDC</td> </tr> <tr> <td></td> <td>Vi+</td> <td></td> </tr> <tr> <td></td> <td>Vi-</td> <td></td> </tr> <tr> <td></td> <td>FG</td> <td></td> </tr> <tr> <th>Pin number</th> <th>Signal</th> <th>Description</th> </tr> <tr> <td>1</td> <td>Vi+</td> <td>Power (12-24VDC±5%)</td> </tr> <tr> <td>2</td> <td>Vi-</td> <td>Power (GND)</td> </tr> <tr> <td>3</td> <td>FG</td> <td>Frame Grand</td> </tr> </tbody> </table>	Power connector	MC1,5/3-G-3,5 (Phoenix Contact)		12-24VDC				Vi+			Vi-			FG		Pin number	Signal	Description	1	Vi+	Power (12-24VDC±5%)	2	Vi-	Power (GND)	3	FG	Frame Grand
Power connector	MC1,5/3-G-3,5 (Phoenix Contact)																											
12-24VDC																												
	Vi+																											
	Vi-																											
	FG																											
Pin number	Signal	Description																										
1	Vi+	Power (12-24VDC±5%)																										
2	Vi-	Power (GND)																										
3	FG	Frame Grand																										

Table 2.3. 10BASE-T/100BASE-TX/1000BASE-T port

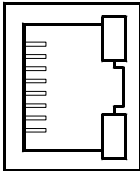
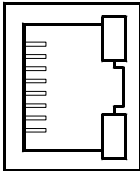
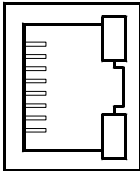
Name	Function																															
10BASE-T/ 100BASE-TX/ 1000BASE-T port	<p>Ports 1 to 8</p> <p>Use these ports to connect personal computers, additional HUB units, bridges, or other devices.</p> <p>Communication rate (10/100/1000Mbps) and communication method (half/full duplex) can be automatically recognized. Using the Auto MDI/MDI-X function, the cable type (straight-through or crossover cable) can be automatically recognized.</p> <table border="1" style="margin: 10px auto;"> <thead> <tr> <th>Used connector</th> <th>JC0-0182NL (Pulse)</th> </tr> </thead> <tbody> <tr> <td colspan="2" style="text-align: center;">  </td> </tr> <tr> <th>Pin name</th> <th>Signal</th> <th>Description</th> </tr> <tr> <td>1</td> <td>TRD+ (0)</td> <td>Data0 transmit and receive (+)</td> </tr> <tr> <td>2</td> <td>TRD- (0)</td> <td>Data0 transmit and receive (-)</td> </tr> <tr> <td>3</td> <td>TRD+ (1)</td> <td>Data1 transmit and receive (+)</td> </tr> <tr> <td>4</td> <td>TRD+ (2)</td> <td>Data2 transmit and receive (+)</td> </tr> <tr> <td>5</td> <td>TRD- (2)</td> <td>Data2 transmit and receive (-)</td> </tr> <tr> <td>6</td> <td>TRD- (1)</td> <td>Data1 transmit and receive (-)</td> </tr> <tr> <td>7</td> <td>TRD+ (3)</td> <td>Data3 transmit and receive (+)</td> </tr> <tr> <td>8</td> <td>TRD- (3)</td> <td>Data3 transmit and receive (-)</td> </tr> </tbody> </table>	Used connector	JC0-0182NL (Pulse)			Pin name	Signal	Description	1	TRD+ (0)	Data0 transmit and receive (+)	2	TRD- (0)	Data0 transmit and receive (-)	3	TRD+ (1)	Data1 transmit and receive (+)	4	TRD+ (2)	Data2 transmit and receive (+)	5	TRD- (2)	Data2 transmit and receive (-)	6	TRD- (1)	Data1 transmit and receive (-)	7	TRD+ (3)	Data3 transmit and receive (+)	8	TRD- (3)	Data3 transmit and receive (-)
Used connector	JC0-0182NL (Pulse)																															
																																
Pin name	Signal	Description																														
1	TRD+ (0)	Data0 transmit and receive (+)																														
2	TRD- (0)	Data0 transmit and receive (-)																														
3	TRD+ (1)	Data1 transmit and receive (+)																														
4	TRD+ (2)	Data2 transmit and receive (+)																														
5	TRD- (2)	Data2 transmit and receive (-)																														
6	TRD- (1)	Data1 transmit and receive (-)																														
7	TRD+ (3)	Data3 transmit and receive (+)																														
8	TRD- (3)	Data3 transmit and receive (-)																														

Power Supply

Use a power supply capable of establishing 11.6VDC or higher within 50ms. Power supplies that can not meet this requirement may cause device failures or accidents.

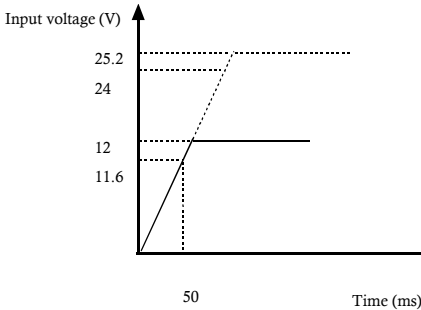

Figure 2.2. Time required to establish certain voltage

3. Setup of Hardware

Mounting/Removing a Unit on/from a DIN Rail

Mounting Procedure

- (1) Hook the upper clips of a DIN rail mounting bracket to the upper groove of a DIN rail, and then push the lower part of the unit to the DIN rail.

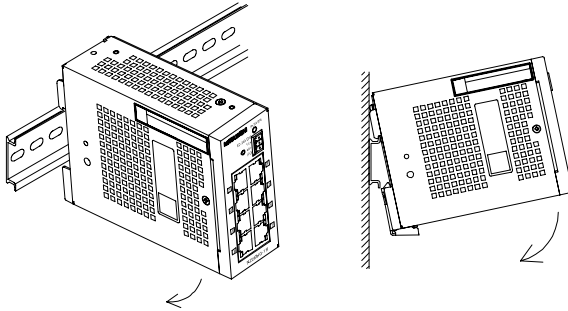

Figure 3.1. Mounting a unit on a DIN rail < 1 / 2 >

- (2) The DIN rail mounting mechanism automatically locks so that the unit can be attached with one simple motion.

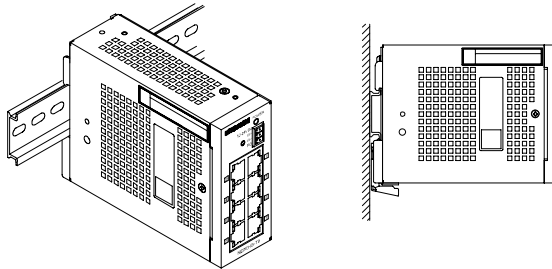

Figure 3.2. Mounting a unit on a DIN rail < 2 / 2 >

Removing Procedure

A phillips-head screwdriver or a flathead screwdriver is required to remove a unit from a DIN rail.

⚠ CAUTION

Disconnect LAN cables and power cables connected to the unit before removing from the DIN rail.

For a Phillips-head screwdriver

- (1) Insert a phillips-head screwdriver (diameter: 6 to 7mm) into the latch metal fitting on the lower part of the unit. Do not use excessive force. Doing so may damage the DIN rail mounting bracket or the unit.

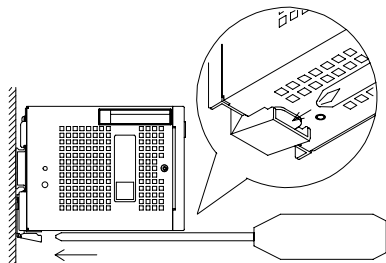

Figure 3.3. Removing a unit from a DIN rail with a phillips-head screwdriver < 1 / 3 >

- (2) The latch metal fitting is pushed down and the unit is ready to be removed from the DIN rail.

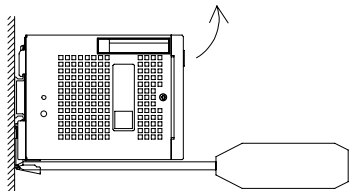

Figure 3.4. Removing a unit from a DIN rail with a phillips-head screwdriver < 2 / 3 >

- (3) By lifting the unit, you can easily remove it from the DIN rail.

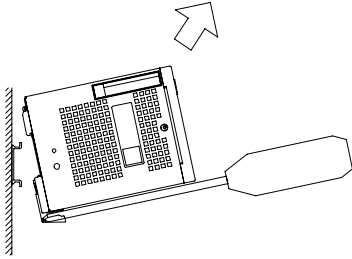

Figure 3.5. Removing a unit from a DIN rail with a phillips-head screwdriver < 3 / 3 >

For a flathead screwdriver

- (1) Insert a flathead screwdriver (tooth width 5.5 to 7mm) into the latch metal fitting on the lower part of the unit, and push the tip of the screwdriver down vertically.

Do not use excessive force. Doing so may damage the DIN rail mounting bracket or the unit.

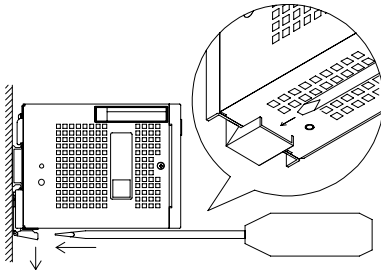

Figure 3.6. Removing a unit from a DIN rail with a flathead screwdriver < 1 / 3 >

- (2) The latch metal fitting is pushed down and the unit is ready to be removed from the DIN rail.

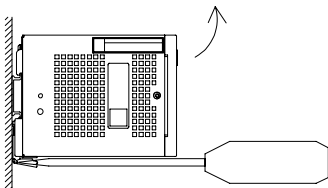

Figure 3.7. Removing a unit from a DIN rail with a flathead screwdriver < 2 / 3 >

(3) By lifting the unit, you can easily remove it from the DIN rail.

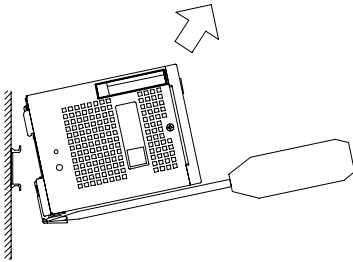

Figure 3.8. Removing a unit from a DIN rail with a flathead screwdriver < 3 / 3 >

Attaching mounting brackets

Attachment

Remove the four screws and separate the DIN rail mounting bracket from the unit.

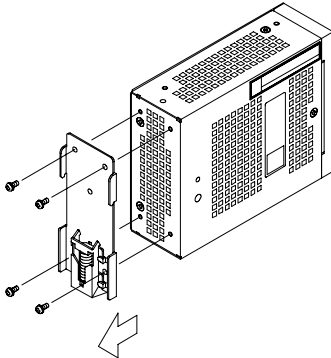

Figure 3.9. Separating the DIN rail mounting bracket

Mounting brackets

Attach mounting brackets to the unit using bracket screws.

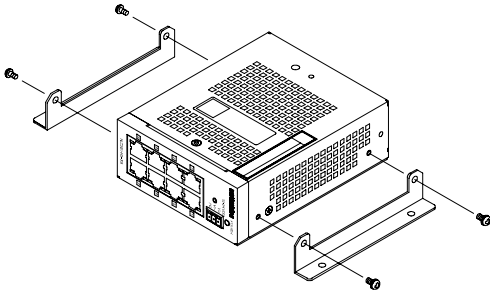

Figure 3.10. Attaching mounting brackets

Attaching a retention bracket

Attachment

- (1) Plug in the power terminal connector to the power connector and attach the retention bracket using a bracket screw.

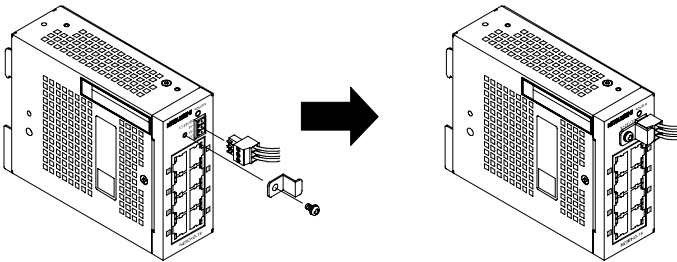

Figure 3.11. Attaching a retention bracket

Installation Conditions

⚠ CAUTION

When used in applications with high environmental temperatures, even if the unit is operated within the temperature range specification, make sure that heat generated by the unit has an adequate dissipation path.

Installation Orientation

When a DIN rail mounting bracket is used

Avoid installation in an unsuitable installation orientation as insufficient heat dissipation may occur.

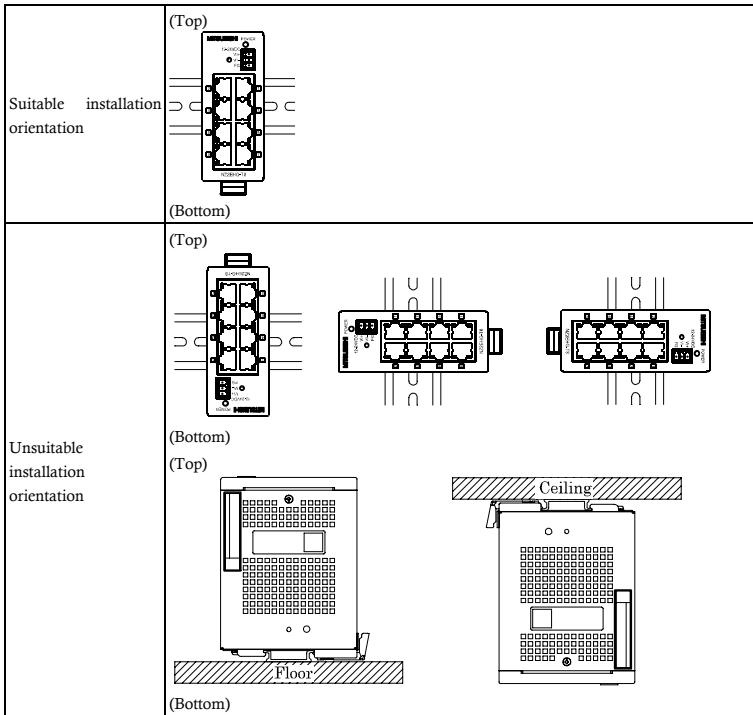

Figure 3.12. Installation orientation (with a DIN rail mounting bracket)

When mounting brackets are used

Installation in any orientation is possible.

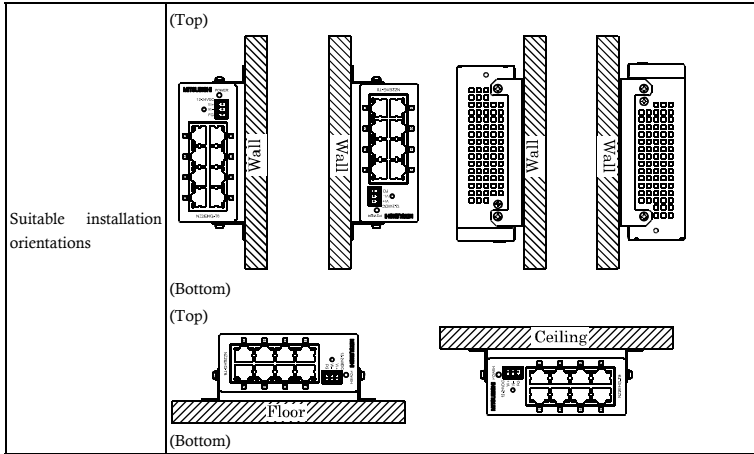

Figure 3.13. Installation orientations (with mounting brackets)

Spacing between Unit and Surrounding Objects



CAUTION

Do not install the unit in a sealed housing.

When installed using a DIN rail mounting bracket

Ensure the distance between the unit and any surrounding objects as follows:

Above and below the unit: 50mm or more

Sides of the unit: 50mm or more (At least 5.8mm on the rating plate side).

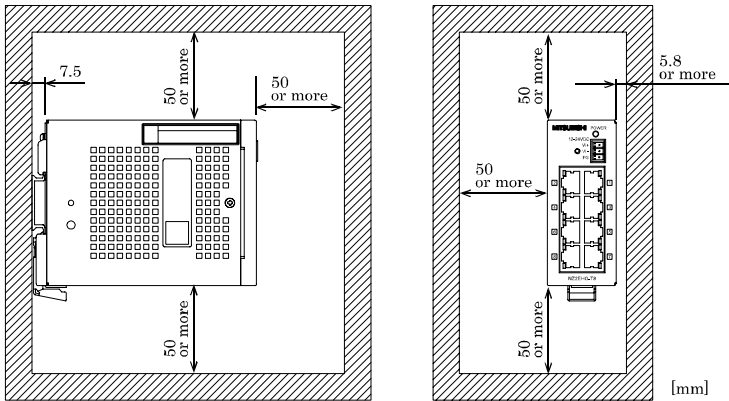

Figure 3.14. Spacing between the unit and any surrounding objects when installed using a DIN rail mounting bracket

When installed using mounting brackets

Ensure the distance between the unit and any surrounding objects as follows:

Above and below the unit: 50mm or more

Under the rating plate side of the unit: 5.8mm or more

On each side of the unit: 50mm or more

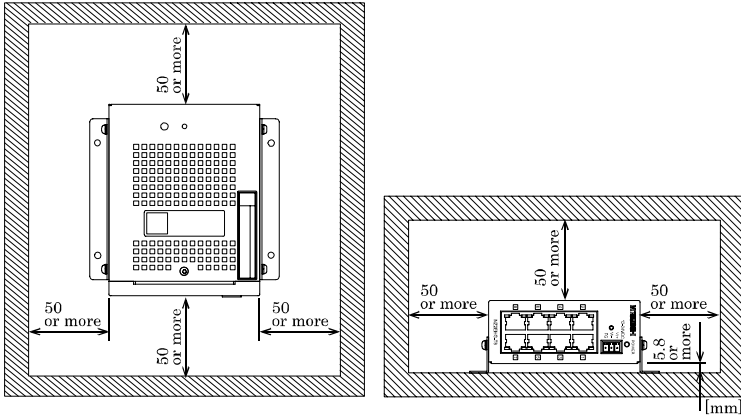

Figure 3.15. Spacing between the unit and any surrounding objects when installed using mounting brackets

4. Connecting to a Network

Network Cables

Cables meeting the following specifications should be used:

- 10BASE-T : Category 3 or higher UTP, STP cable 100m or less
- 100BASE-TX : Category 5 or higher UPT, STP cable 100m or less
- 1000BASE-T : Category 5e or higher UTP, STP cable 100m or less
- There are two types for UTP and STP cables: a straight-through cable and a crossover cable. The Auto MDI/MDI-X feature allows connections using either type of a cable.

Connecting to Programmable Controllers, Personal Computers, Additional HUB Units, or Bridges

When connecting a programmable controller, personal computer, additional HUB unit, bridge, or other device, connect it to any 10BASE-T/100BASE-TX/1000BASE-T port of the switching HUB unit using either a straight-through or crossover cable.

CAUTION

To use Jumbo Frame, it is necessary for other network devices of the communication target, such as LAN adapters, to be Jumbo Frame compatible.

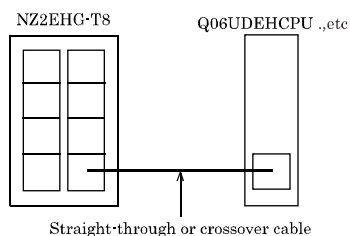

Figure 4.1. Connection example

Connection Restrictions for 100BASE-TX Repeater HUBs

Using Class I 100BASE-TX repeater HUBs, cascade connections are not possible. Up to two stages of cascade connections are possible with Class II 100BASE-TX repeater HUBs. In addition, the maximum total length of cables (1) (2) (3) is 205m or less. For details, refer to the user's manual for the 100BASE-TX repeater HUB used.

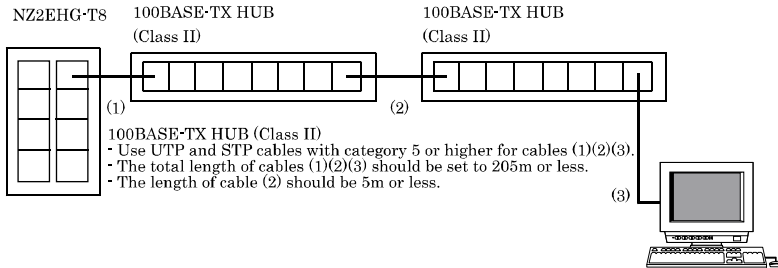

Figure 4.2. Connection restrictions for 100BASE-TX repeater HUBs (Class II)

Connection Restrictions for 10BASE-T Repeater HUBs

As many as four stages of 10BASE-T repeater HUBs can be connected using cascade connection. In addition, the length of UTP or STP cable between cascaded HUBs is 100m or less. For details, refer to the user's manual for the 10BASE-T repeater HUB used.

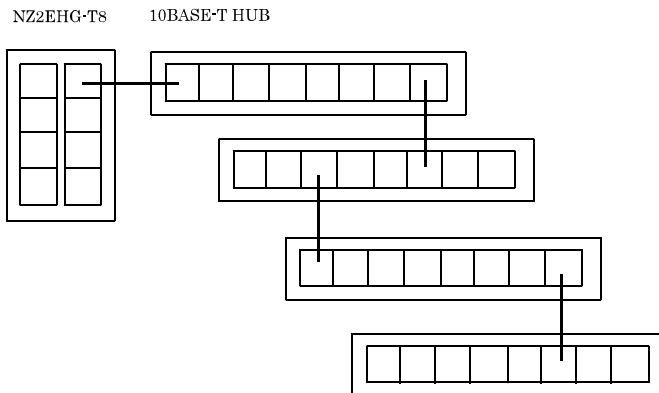

Figure 4.3. Connection restrictions for 10BASE-T repeater HUBs

5. System Reference

Specifications

Table 5.1. Specifications

Item	Specifications
Ethernet standards	IEEE802.3/IEEE802.3u /IEEE802.3ab –compliant
Data communication rate	10/100/1000Mbps (auto-recognition)
Access method	CSMA/CD
Communication method	All ports: Full/Half duplex (auto-recognition)
Topology	Star topology
Flow control	Full Duplex : IEEE802.3x compliant flow control Half Duplex :Back pressure
Number of effective ports	8
Switching method	Store and forward
Address table	8,192 entries
Jumbo frame*1	9.6Kbyte
Buffer capacity	176Kbyte
Aging time	300s (Max.)
LED indicator	POWER (Green), LINK/ACT 10M (Yellow), LINK/ACT 100M (Green), LINK/ACT 1000M (Green)
Power supply voltage	12V - 24VDC±5%
FG terminal	The power connector is equipped with FG terminal.
Power consumption (Max.)	0.60A at 12VDC, 0.40A at 24VDC
Physical dimensions (mm)	39 (W) x 120 (D) x 94 (H) (excluding protrusions)
Weight	360g (410g with a DIN rail mounting bracket or two mounting brackets)
Installation method	Onto a DIN rail or on the wall

*1 To use Jumbo Frame, it is necessary for other network devices on the communication route to be Jumbo Frame compatible.

Table 5.2. Installation environment requirements

Item		Specification
Operating ambient temperature		0 to 50°C
Storage ambient temperature		-10 to 60°C
Ambient humidity		10 to 90%RH (No condensation)
Floating dust particles		Tolerant of small amounts (non excessive)
Corrosive gases		None
Noise immunity	Line-noise	AC line/2kV, Signal line/1kV (JIS C61000-4-4 Level 3, IEC61000-4-4 Level 3)
	Electrostatic discharge immunity	Contact discharge/4kV (JIS C61000-4-2 Level 2, IEC61000-4-2 Level 2) Air discharge/8kV (JIS C61000-4-2 Level 3, IEC61000-4-2 Level 3)
Vibration resistance	Sweep resistance	10 to 57Hz/ half amplitude 0.15mm, 57 to 150Hz/2.0G 40minutes each in X, Y, and Z directions (JIS C60068-2-6-compliant, IEC60068-2-6-compliant)
Shock resistance		15G, sine half-wave pulse for 11ms each in X, Y, and Z directions (JIS C60068-2-27-compliant, IEC60068-2-27-compliant)
Grounding		Ground the FG terminal to the protective ground conductor.
Installation location		Inside a control panel

External Dimensions

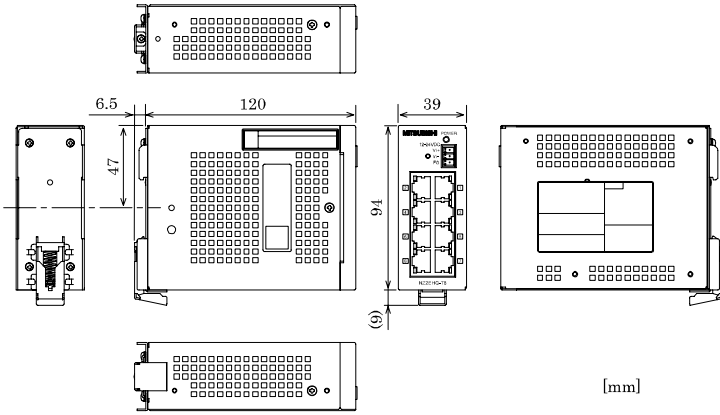

Figure 5.1. External dimensions with a DIN rail mounting bracket (standard)

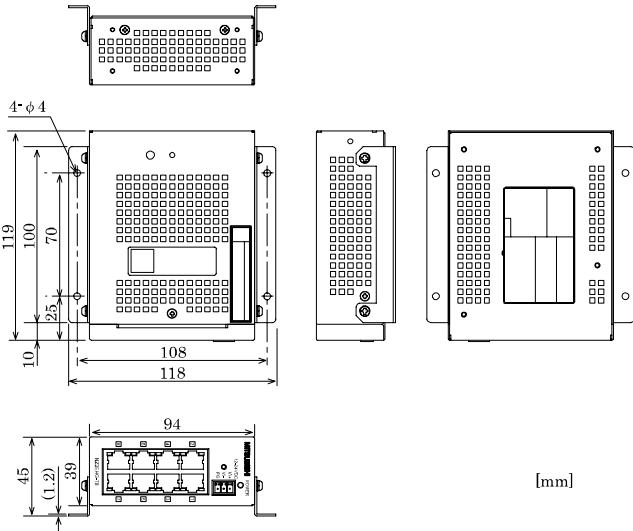

Figure 5.2. External dimensions with mounting brackets

EMC Directive

Compliance with the EMC Directive, which is one of the EU directives, has been mandatory for the products sold within EU member states since 1996.

To prove the compliance with the EMC Directive, manufactures must issue an EC Declaration of Conformity and the products must bear a CE marking.

This product is compliant to with EN55022, EN55024, and EN61000-6-2.

(1) Authorized representative in EU member states

The authorized representative in EU member states will be:

Company name : Mitsubishi Electric Europe BV

Address : Gothaer strasse 8, 40880 Ratingen, Germany

WARRANTY

Please confirm the following product warranty details before using this product.

1. Gratis Warranty Term and Gratis Warranty Range

If any faults or defects (hereinafter "Failure") found to be the responsibility of Mitsubishi occurs during use of the product within the gratis warranty term, the product shall be repaired at no cost via the sales representative or Mitsubishi Service Company.

However, if repairs are required onsite at domestic or overseas location, expenses to send an engineer will be solely at the customer's discretion. Mitsubishi shall not be held responsible for any re-commissioning, maintenance, or testing on-site that involves replacement of the failed module.

[Gratis Warranty Term]

The gratis warranty term of the product shall be for one year after the date of purchase or delivery to a designated place.

Note that after manufacture and shipment from Mitsubishi, the maximum distribution period shall be six (6) months, and the longest gratis warranty term after manufacturing shall be eighteen (18) months. The gratis warranty term of repair parts shall not exceed the gratis warranty term before repairs.

[Gratis Warranty Range]

- (1) The range shall be limited to normal use within the usage state, usage methods and usage environment, etc., which follow the conditions and precautions, etc., given in the instruction manual, user's manual and caution labels on the product.
- (2) Even within the gratis warranty term, repairs shall be charged for in the following cases.
 1. Failure occurring from inappropriate storage or handling, carelessness or negligence by the user. Failure caused by the user's hardware or software design.
 2. Failure caused by unapproved modifications, etc., to the product by the user.
 3. When the Mitsubishi product is assembled into a user's device, Failure that could have been avoided if functions or structures, judged as necessary in the legal safety measures the user's device is subject to or as necessary by industry standards, had been provided.
 4. Failure that could have been avoided if consumable parts (battery, backlight, fuse, etc.) designated in the instruction manual had been correctly serviced or replaced.
 5. Failure caused by external irresistible forces such as fires or abnormal voltages, and Failure caused by force majeure such as earthquakes, lightning, wind and water damage.
 6. Failure caused by reasons unpredictable by scientific technology standards at time of shipment from Mitsubishi.
 7. Any other failure found not to be the responsibility of Mitsubishi or that admitted not to be so by the user.

2. Onerous repair term after discontinuation of production

(1) Mitsubishi shall accept onerous product repairs for six (6) years after production of the product is discontinued.

Discontinuation of production shall be notified with Mitsubishi Technical Bulletins, etc.

(2) Product supply (including repair parts) is not available after production is discontinued.

3. Overseas service

Overseas, repairs shall be accepted by Mitsubishi's local overseas FA Center. Note that the repair conditions at each FA Center may differ.

4. Exclusion of loss in opportunity and secondary loss from warranty liability

Regardless of the gratis warranty term, Mitsubishi shall not be liable for compensation of damages caused by any cause found not to be the responsibility of Mitsubishi, loss in opportunity, lost profits incurred to the user by Failures of Mitsubishi products, special damages and secondary damages whether foreseeable or not, compensation for accidents, and compensation for damages to products other than Mitsubishi products, replacement by the user, maintenance of on-site equipment, start-up test run and other tasks.

5. Changes in product specifications

The specifications given in the catalogs, manuals or technical documents are subject to change without prior notice.

Revisions

*The manual number is given on the bottom right of the cover.

Print Date	*Manual Number	Revision
January 2010	IB(NA)-0800460-A	First edition
February 2010	IB(NA)-0800460-B	Partially revised Precautions regarding Warranty and Specifications, Safety Precautions, Chapter 2, 3 and 5
July 2010	IB(NA)-0800460-C	Partially revised Precautions regarding Warranty and Specifications, Safety Precautions, Chapter 1, 2, 3 and 5

Country/Region Sales office/Tel

U.S.A Mitsubishi Electric Automation Inc.
500 Corporate Woods Parkway Vernon
Hills, IL 60061, U.S.A.
Tel : +1-847-478-2100

Brazil MELCO-TEC Rep. Com.e Assessoria
Tecnica Ltda.
Rua Correia Dias, 184,
Edificio Paraiso Trade Center-8 andar
Paraiso, Sao Paulo, SP Brazil
Tel : +55-11-5908-8331

Germany Mitsubishi Electric Europe B.V. German
Branch
Gothaer Strasse 8 D-40880 Ratingen,
GERMANY
Tel : +49-2102-486-0

U.K Mitsubishi Electric Europe B.V. UK
Branch
Travellers Lane, Hatfield, Hertfordshire.,
AL10 8XB, U.K.
Tel : +44-1707-276100

Italy Mitsubishi Electric Europe B.V. Italian
Branch
Centro Dir. Colleoni, Pal. Perseo-Ingr.2
Via Paracelso 12, I-20041 Agrate Brianza.,
Milano, Italy
Tel : +39-039-60531

Spain Mitsubishi Electric Europe B.V. Spanish
Branch
Carretera de Rubi 76-80,
E-08190 Sant Cugat del Valles,
Barcelona, Spain
Tel : +34-93-565-3131

France Mitsubishi Electric Europe B.V. French
Branch
25, Boulevard des Bouvets, F-92741
Nanterre Cedex, France
TEL: +33-1-5568-5568

South Africa Circuit Breaker Industries Ltd.
Private Bag 2016, ZA-1600 Isando,
South Africa
Tel : +27-11-928-2000

Country/Region Sales office/Tel

Hong Kong Mitsubishi Electric Automation
(Hong Kong) Ltd.
10th Floor, Manulife Tower, 169 Electric
Road, North Point, Hong Kong
Tel : +852-2887-8870

China Mitsubishi Electric Automation
(China) Ltd.
4/F Zhi Fu Plazz, No.80 Xin Chang Road,
Shanghai 200003, China
Tel : +86-21-6120-0808

Taiwan Setsuyo Enterprise Co., Ltd.
6F No.105 Wu-Kung 3rd.Rd, Wu-Ku
Hsiang, Taipei Hsine, Taiwan
Tel : +886-2-2299-2499

Korea Mitsubishi Electric Automation Korea Co., Ltd.
1480-6, Gayang-dong, Gangseo-ku
Seoul 157-200, Korea
Tel : +82-2-3660-9552

Singapore Mitsubishi Electric Asia Pte, Ltd.
307 Alexandra Road #05-01/02, Mitsubishi
Electric Building, Singapore 159943
Tel : +65-6470-2460

Thailand Mitsubishi Electric Automation (Thailand)
Co., Ltd.
Bang-Chan Industrial Estate No.111
Moo 4, Serithai Rd, T.Kannayao,
A.Kannayao, Bangkok 10230 Thailand
Tel : +66-2-517-1326

Indonesia P.T. Autoteknindo Sumber Makmur
Muara Karang Selatan, Block A/Utara
No.1 Kav. No.11 Kawasan Industri
Pergudangan Jakarta - Utara 14440,
P.O.Box 5045 Jakarta, 11050 Indonesia
Tel : +62-21-6630833

India Messung Systems Pvt, Ltd.
Electronic Sadan NO:III Unit No15,
M.I.D.C Bhosari, Pune-411026, India
Tel : +91-20-2712-3130

Australia Mitsubishi Electric Australia Pty. Ltd.
348 Victoria Road, Rydalmere,
N.S.W 2116, Australia
Tel : +61-2-9684-7777

MITSUBISHI ELECTRIC CORPORATION

HEAD OFFICE : TOKYO BUILDING, 2-7-3 MARUNOUCHI, CHIYODA-KU, TOKYO 100-8310, JAPAN
NAGOYA WORKS : 1-14, YADA-MINAMI 5-CHOME, HIGASHI-KU, NAGOYA, JAPAN

When exported from Japan, this manual does not require application to the Ministry
of Economy, Trade and Industry for service transaction permission.

Specifications subject to change without notice.