

USER'S MANUAL

3G3AX-DI

DI Board

Introduction

Thank you for choosing the 3G3AX-DI Board. This User's Manual (hereinafter called "this manual") describes the installation/wiring of the 3G3AX-DI model, as well as troubleshooting and inspection methods.

- This manual should be delivered to the actual end user of the product.
- After reading this manual, keep it handy for future reference.
- This manual describes the specifications and functions of the product as well as the relations between them. You should assume that anything not described in this manual is not possible with the product.
- Intended readers
This manual is intended for:
Those with knowledge of electrical systems (qualified electrical engineers or the equivalent), and also in charge of:
 - Introducing the control equipment
 - Designing the control system
 - Installing and/or connecting the control equipment
 - Field management

Read and Understand This Manual

Please read and understand this manual before using the product. Please consult your OMRON representative if you have any questions or comments.

Warranty and Limitations of Liability

WARRANTY
<p>OMRON's exclusive warranty is that the products are free from defects in materials and workmanship for a period of one year (or other period if specified) from date of sale by OMRON.</p> <p>OMRON MAKES NO WARRANTY OR REPRESENTATION, EXPRESS OR IMPLIED, REGARDING NON-INFRINGEMENT, MERCHANTABILITY, OR FITNESS FOR PARTICULAR PURPOSE OF THE PRODUCTS. ANY BUYER OR USER ACKNOWLEDGES THAT THE BUYER OR USER ALONE HAS DETERMINED THAT THE PRODUCTS WILL SUITABLY MEET THE REQUIREMENTS OF THEIR INTENDED USE. OMRON DISCLAIMS ALL OTHER WARRANTIES, EXPRESS OR IMPLIED.</p>

LIMITATIONS OF LIABILITY
<p>OMRON SHALL NOT BE RESPONSIBLE FOR SPECIAL, INDIRECT, OR CONSEQUENTIAL DAMAGES, LOSS OF PROFITS OR COMMERCIAL LOSS IN ANY WAY CONNECTED WITH THE PRODUCTS, WHETHER SUCH CLAIM IS BASED ON CONTRACT, WARRANTY, NEGLIGENCE, OR STRICT LIABILITY.</p> <p>In no event shall the responsibility of OMRON for any act exceed the individual price of the product on which liability is asserted.</p> <p>IN NO EVENT SHALL OMRON BE RESPONSIBLE FOR WARRANTY, REPAIR, OR OTHER CLAIMS REGARDING THE PRODUCTS UNLESS OMRON'S ANALYSIS CONFIRMS THAT THE PRODUCTS WERE PROPERLY HANDLED, STORED, INSTALLED, AND MAINTAINED AND NOT SUBJECT TO CONTAMINATION, ABUSE, MISUSE, OR INAPPROPRIATE MODIFICATION OR REPAIR.</p>

Application Considerations

SUITABILITY FOR USE

OMRON shall not be responsible for conformity with any standards, codes, or regulations that apply to the combination of products in the customer's application or use of the products.

At the customer's request, OMRON will provide applicable third party certification documents identifying ratings and limitations of use that apply to the products. This information by itself is not sufficient for a complete determination of the suitability of the products in combination with the end product, machine, system, or other application or use.

The following are some examples of applications for which particular attention must be given. This is not intended to be an exhaustive list of all possible uses of the products, nor is it intended to imply that the uses listed may be suitable for the products:

- Outdoor use, uses involving potential chemical contamination or electrical interference, or conditions or uses not described in this manual.
- Nuclear energy control systems, combustion systems, railroad systems, aviation systems, medical equipment, amusement machines, vehicles, safety equipment, and installations subject to separate industry or government regulations.
- Systems, machines, and equipment that could present a risk to life or property.

Please know and observe all prohibitions of use applicable to the products.

NEVER USE THE PRODUCTS FOR AN APPLICATION INVOLVING SERIOUS RISK TO LIFE OR PROPERTY WITHOUT ENSURING THAT THE SYSTEM AS A WHOLE HAS BEEN DESIGNED TO ADDRESS THE RISKS, AND THAT THE OMRON PRODUCTS ARE PROPERLY RATED AND INSTALLED FOR THE INTENDED USE WITHIN THE OVERALL EQUIPMENT OR SYSTEM.

PROGRAMMABLE PRODUCTS

OMRON shall not be responsible for the user's programming of a programmable product, or any consequence thereof.

Disclaimers

CHANGE IN SPECIFICATIONS

Product specifications and accessories may be changed at any time based on improvements and other reasons.

It is our practice to change model numbers when published ratings or features are changed, or when significant construction changes are made. However, some specifications of the products may be changed without any notice. When in doubt, special model numbers may be assigned to fix or establish key specifications for your application on your request. Please consult with your OMRON representative at any time to confirm actual specifications of purchased products.

DIMENSIONS AND WEIGHTS

Dimensions and weights are nominal and are not to be used for manufacturing purposes, even when tolerances are shown.

PERFORMANCE DATA

Performance data given in this manual is provided as a guide for the user in determining suitability and does not constitute a warranty. It may represent the result of OMRON's test conditions, and the users must correlate it to actual application requirements. Actual performance is subject to the OMRON Warranty and Limitations of Liability.

ERRORS AND OMISSIONS

The information in this manual has been carefully checked and is believed to be accurate; however, no responsibility is assumed for clerical, typographical, or proofreading errors, or omissions.



Safety Precautions

■ Indications and Meanings of Safety Information









In this user's manual, the following precautions and signal words are used to provide information to ensure the safe use of the 3G3AX-DI Board.

The information provided here is vital to safety. Strictly observe the precautions provided.

■ Meanings of Signal Words

 WARNING	Indicates an imminently hazardous situation which, if not avoided, is likely to result in serious injury or may result in death. Additionally there may be severe property damage.
 CAUTION	Indicates a potentially hazardous situation which, if not avoided, may result in minor or moderate injury, or in property damage.

■ Alert Symbols in This Document

 WARNING	
	Turn off the power supply and implement wiring correctly. Not doing so may result in a serious injury due to an electric shock.
	Wiring work must be carried out only by qualified personnel. Not doing so may result in a serious injury due to an electric shock.
	Do not touch the surface of the DI Board or terminals, and do not remove the signal wire or the DI Board while the power is being supplied. Doing so may result in a serious injury due to an electric shock or fire.
	Turn off the input power of the Inverter and wait for more than 10 minutes before putting on or taking off the DI Board, changing the setting / wiring or conducting inspection. Not doing so may result in a serious injury due to an electric shock.
 CAUTION	
	Place covers on the openings or take other precautions to make sure that no metal objects such as cutting bits or lead wire scraps go inside when installing the DI Board and wiring.
	Install a stop motion device to ensure safety. Not doing so might result in a minor injury.
	Do not dismantle, repair or modify the product. Doing so may result in an injury.

Precautions for Safe Use

■ Installation and Storage

Do not store or use the product in the following places.

- Locations subject to direct sunlight.
- Locations subject to ambient temperature exceeding the specifications.
- Locations subject to relative humidity exceeding the specifications.
- Locations subject to condensation due to severe temperature fluctuations.
- Locations subject to corrosive or flammable gases.
- Locations subject to exposure to combustibles.
- Locations subject to dust (especially iron dust) or salt.
- Locations subject to exposure to water, oil, or chemicals.
- Locations subject to shock or vibration.

■ Transportation, Installation, and Wiring

Observe the following instructions during transportation, installation, and wiring.

- Do not drop or apply a strong impact on the product. Doing so may result in damaged parts or malfunction.
- Connect the DI Board to the Inverter tightly with the provided fixing screws.
Tighten securely the terminal screws for the signal wire on the DI Board.
Tightening torque: 0.9 N·m (1.0 N·m max.)
- Be sure to use the provided ferrite cores. Fix the ferrite cores on the wire or take appropriate measures so that the ferrite cores will not cover the shield coating of the wire. Not doing so may cause the Inverter to malfunction.
- Fix the shielding wire properly or take appropriate measures so that the wire will not be weighed down.
Not doing so may result in shielding wire breakage due to the weight of the ferrite cores.
- Check whether the motor rotation direction is correct, and unusual sound or vibration occurs during operation.

■ Maintenance and Inspection

Be sure to confirm safety before conducting maintenance, inspection or parts replacement.

Precautions for Correct Use

Rated Voltage

When connecting external power to the power terminal for the interface, confirm that the external power voltage is the same as the rated voltage (24 V DC) of the product.

Product Disposal

Comply with the local ordinance and regulations when disposing of the product.

Checking Before Unpacking

Checking the Product

On delivery, be sure to check that the delivered product is the 3G3AX-DI Board that you ordered. Should you find any problems with the product, immediately contact your nearest local sales representative or OMRON sales office.

■Checking the Nameplate

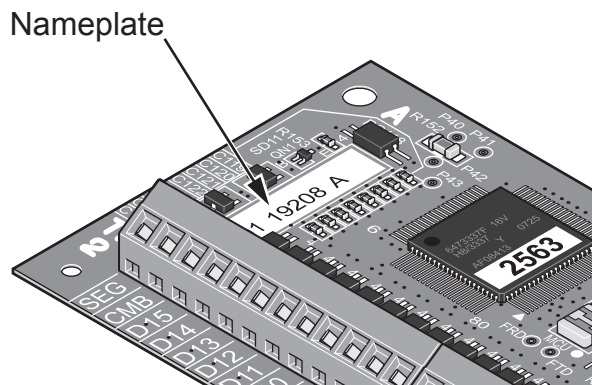

■Checking the Model

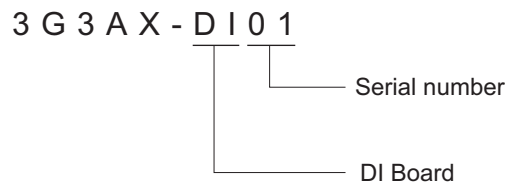

Checking the Accessories

Accessories of the 3G3AX-DI Board are shown below.

- Fixing screws (M3 x 8) : 2
- Ferrite cores : 2

Revision History

A manual revision code appears as a suffix to the catalog number located at the lower left of the front and back covers.

Cat.No.	I565-E1-01
----------------	-------------------

↑
Revision code

Revision code	Revision date	Changes and revision pages
01	April 2008	First printing

About This Manual

This User's Manual is compiled chapter by chapter for user's convenience as follows:
Understanding the following configuration ensures more effective use of the product.

Chapter		Overview
Chapter 1	Overview	Describes the overview of this product.
Chapter 2	Design	Describes the mounting method of the product, terminal names, wiring, and switch settings.
Chapter 3	Functions	Describes parameters for each function, type codes, and data input timing chart.
Chapter 4	Maintenance Operations	Describes precautions for switch settings and data input.

Contents

Introduction.....	1
Read and Understand This Manual.....	2
Safety Precautions	5
Precautions for Safe Use.....	6
Precautions for Correct Use	7
Checking Before Unpacking	8
Revision History.....	9
About This Manual.....	10
Chapter 1 Overview	
1-1 Overview.....	1-1
Chapter 2 Design	
2-1 Mounting the DI Board.....	2-1
2-2 Terminal Arrangement.....	2-2
2-3 Connection to Programmable Controllers.....	2-3
2-4 Terminal Functions	2-5
2-5 Wiring.....	2-6
2-6 Switch Settings	2-8
2-7 Inverter Settings.....	2-9
2-8 Input Mode Settings.....	2-10
Chapter 3 Functions	
3-1 Parameter Description of Each Function	3-1
3-2 Type Code	3-5
3-3 Data Input Timing	3-6
Chapter 4 Maintenance Operations	
4-1 Precautions for Setting the Switches	4-1
4-2 Precautions for Data Input.....	4-2
4-3 Protective Function	4-3

Contents

Chapter 1

Overview

1-1 Overview	1-1
--------------------	-----

1-1 Overview

The DI Board (3G3AX-DI) is an optional board for the 3G3RX Series Inverter. With this board, you can digitally input the set frequency, acceleration time setting, deceleration time setting, torque setting and position (orientation stop position) setting.

Note that the PG Board (3G3AX-PG) is required separately for position control through position setting inputs.

Chapter 2

Design

2-1	Mounting the DI Board.....	2-1
2-2	Terminal Arrangement.....	2-2
2-3	Connection to Programmable Controllers.....	2-3
2-4	Terminal Functions	2-5
2-5	Wiring	2-6
2-6	Switch Settings	2-8
2-7	Inverter Settings	2-9
2-8	Input Mode Settings.....	2-10

2-1 Mounting the DI Board

2

Securely mount the DI Board as shown below.

Place the four holes (in the corners) and the connector (on the back) of the DI Board on Board port 1 (or port 2) correctly with the two holes on the guideposts and the other two on the screw holes.

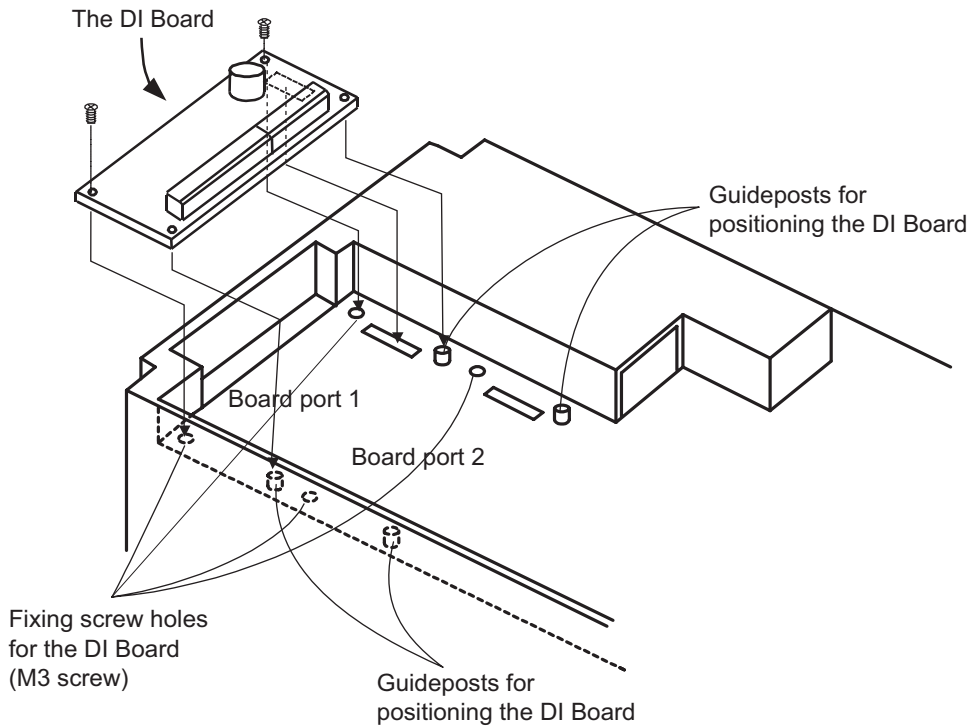

Precautions for Correct Use

To mount the DI Board, be sure to tightly fix it with the two provided fixing screws after putting in place the connector securely. Otherwise, the Inverter will not operate properly.

2-2 Terminal Arrangement

The terminal arrangement on the 3G3AX-DI is shown below.

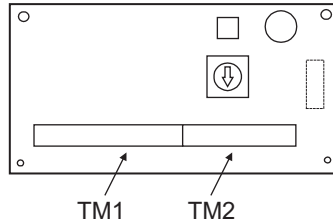

TM1											TM2										
SEQ	CMB	D15	D14	D13	D12	D11	D10	D9	D8	D7	D6	D5	D4	D3	D2	D1	D0	STRB	P24B	PLCB	CM1

The standard terminal connection of the 3G3AX-DI is shown below.

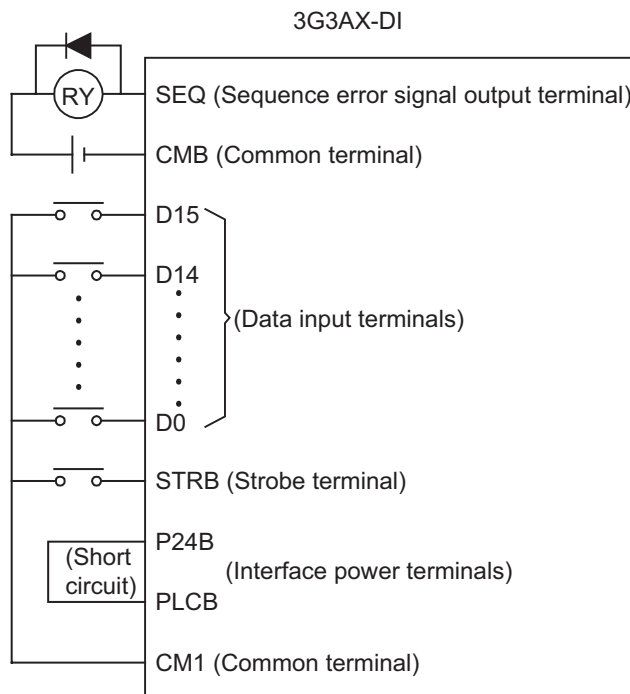

Power is supplied to the input terminals (D0 to D15, STRB) when short-circuiting the P24B and PLCB terminals for the sink logic interface, and short-circuiting the CM1 and PLCB terminals for the source logic interface.

2-3 Connection to Programmable Controllers

When connecting the DI Board to a programmable controller, there are four connection patterns for input terminals, and two for output terminals.

Connect the DI Board according to your programmable controller.

Design

Connection of Input Terminals (D0 to D15, STRB, CM1) and Programmable Controller

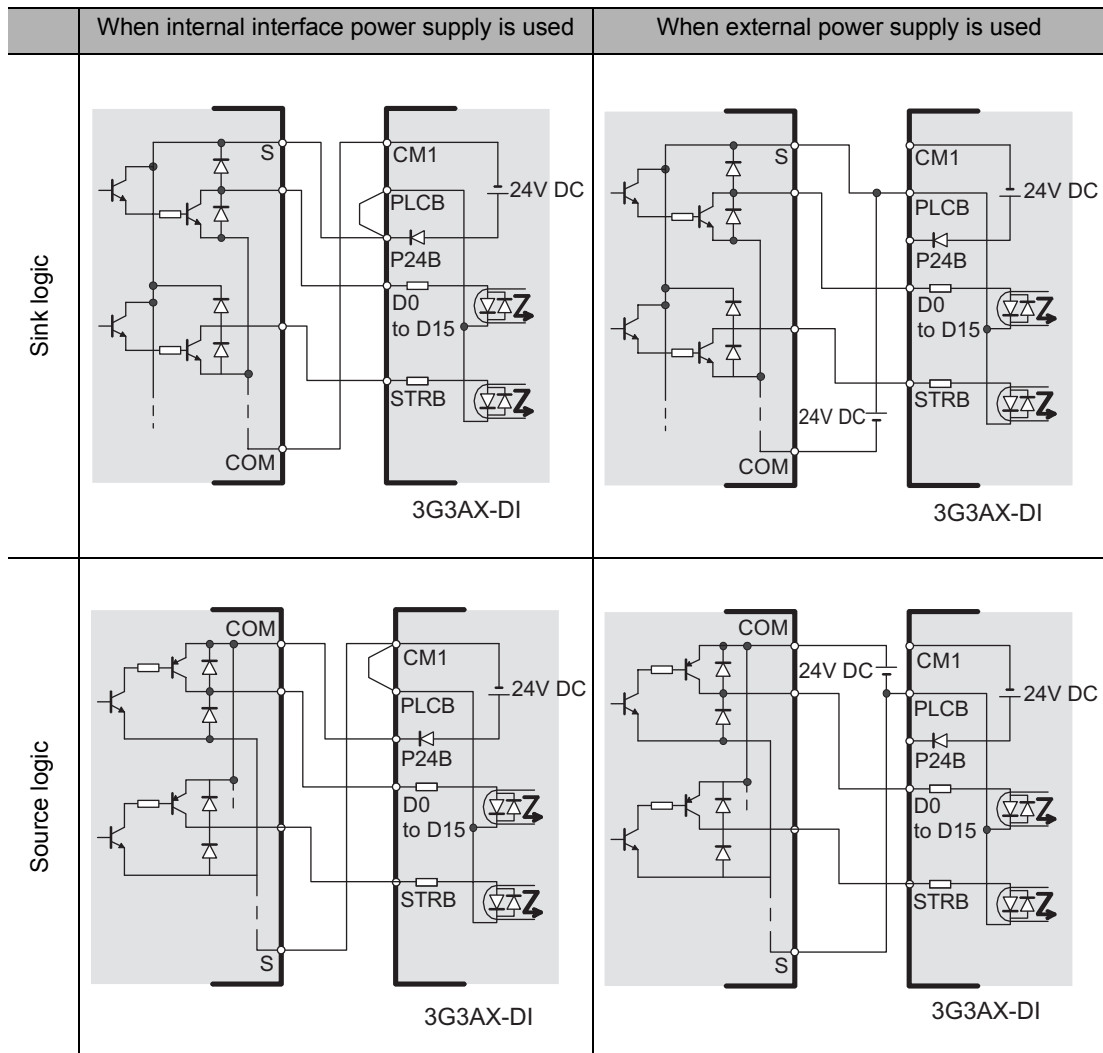

Connection of Output Terminals (SEQ,CMB) and Programmable Controller

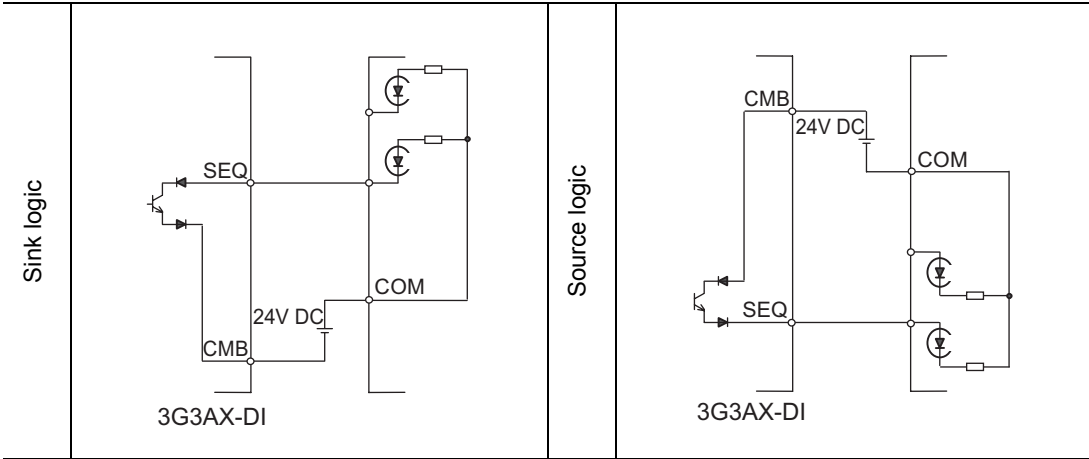

2-4 Terminal Functions

The terminal specifications list is shown below.

	Terminal symbol	Terminal name	Functions	Electric characteristics
Input terminal	D0 to D15	Data input terminal	Photocoupler input (1 NO contact signal) Available at sink/source logic	Between (D0 to 15•STRB) and CM1 Input ON voltage: 18 V DC Input impedance: 4.7 kΩ Max. allowable voltage: 27 V DC
	STRB	Strobe terminal (Data retrieval command signal terminal)		
Output terminal	SEQ	Sequence error signal output terminal (Data input error signal output terminal)	Open collector output Available at sink/source logic	Between SEQ and CMB Voltage drop at power-ON: 4 V max. Max. allowable voltage: 27 V DC Max. allowable current: 50 mA
	CMB	Common terminal for sequence error signal output	Common terminal only for sequence error signal output*1	–
Power supply	P24B	Interface power terminal	24 V DC power supply for contact input signal (When the source logic is selected, this terminal functions as the contact input common terminal.)	Max. allowable current: 90 mA
	CM1	Interface power common terminal	Common terminal for interface power, data input and strobe terminals	–

*1.Do not ground the terminal.

2-5 Wiring

Applicable Wiring

Be sure to observe the following wiring conditions:

- For the signal line, use a shield wire of 0.5 mm² or less.
- Strip the signal line by 5 to 6 mm, and connect the exposed wire.
- In the case of stranded wires, make sure that the wires are not unraveled.
- Make sure that the maximum outside coating diameter of the signal line is 2.0 mm or less.
- Do not exceed 20 m for the wiring length of the shield wire.

The shield wire could be easily influenced by outside noise depending on the shielding method, resulting in an Inverter failure. Generally connect to the power supply ground of a signal line or to the ground for shielding. (To connect to the ground, be careful of the ground cabling route, and avoid multi-point grounding.)

Mounting the Ferrite Cores

The ferrite core mounting method is shown below.

Mount the two provided ferrite cores.

Connect the wire to the CM1 terminal of the 3G3AX-DI Board through the ferrite cores for shielding.

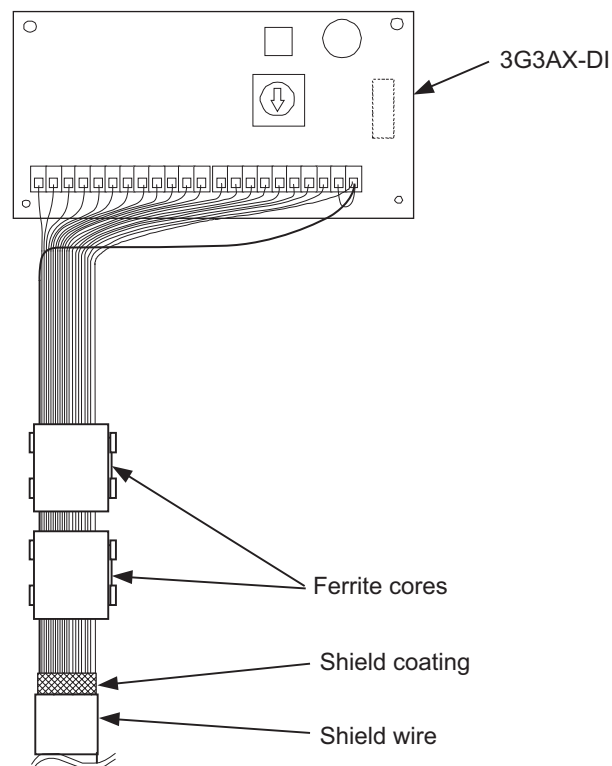

Precautions for Correct Use

If the ferrite cores cover the shield coating, they fail to work effectively, causing the Inverter to malfunction. Be sure to fix the ferrite cores or take other appropriate measures so that they do not overlap the shield coating.

The shield wire connected to the terminal could become disconnected due to the weight of the ferrite cores. Be sure to fix the ferrite cores or take other appropriate measures so that the shield wire does not receive the weight of the ferrite cores.

2-6 Switch Settings

Switch Arrangement

The switch arrangement is shown below.

PAC, DIV, BIN, and BCD marked around the DIP switch (TYPE) indicate batch input, dividing input, binary input, and BCD input, respectively.

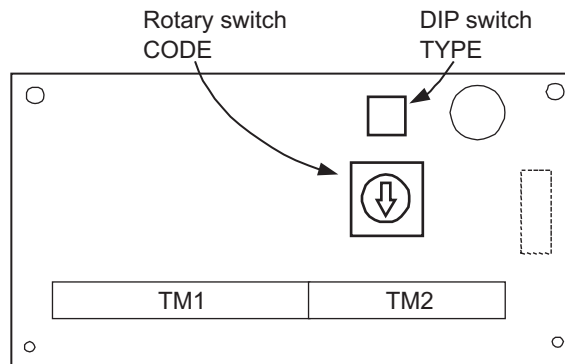

Default setting

The default settings (factory settings) are shown below.

Setting item	Switch No.	Default setting
DIP switch TYPE	1	OFF (Binary input: BIN)
	2	OFF (Batch input mode: PAC)
Rotary switch CODE	–	0 (Set frequency: 0.01 Hz)

2-7 Inverter Settings

The Inverter (3G3RX) parameters related to the operation of the 3G3AX-DI Board are shown below.

For operation, refer to "Chapter 3 Operation" and "Chapter 4 Functions" of the Inverter 3G3RX User's Manual, and make appropriate settings.

Parameter No.	Function name	Data range	Default setting (3G3RX)	Changes during operation	Unit
A001	Frequency reference selection	00: Digital Operator (FREQ adjuster) (Enabled when 3G3AX-OP01 is connected.) 01: Terminal 02: Digital Operator (F001) 03: ModBus communication 04: Option 1 05: Option 2 06: Pulse train frequency 07: Not used 10: Frequency operation result	02	×	—
b040	Torque limit selection	00: Four-quadrant separate setting 01: Terminal switch 02: Analog input 03: Option 1 04: Option 2	00	×	—
P031	Acceleration/Deceleration time input type	00: Digital Operator 01: Option 1 02: Option 2	00	×	—
P032	Orientation stop position input type	00: Digital Operator 01: Option 1 02: Option 2	00	×	—

Note 1: To set the frequency, set the frequency reference selection (A001) to "Option" (04 or 05).

Note 2: To set the acceleration/deceleration time, set the acceleration/deceleration time input type (P031) to "Option".

Note 3: To set the torque limit, set the torque limit selection (b040) to "Option".

Note 4: To set the orientation stop position, set the orientation stop position input type (P032) to "Option".

2-8 Input Mode Settings

The input mode and resolution are selected by the combination of the DIP switch and rotary switch settings of the DI Board.

The input mode list is shown below.

DIP switch (TYPE)		Rotary switch (CODE)	Resolution setting									
			Set frequency				Acceleration/Deceleration time setting			Torque limit setting	Position setting	
Switch No.		Setting code	0.01 Hz	0.1 Hz	1 Hz	Rate	0.01 sec	0.1 sec	1 sec	1%	1 pulse	
1	2											
ON: BCD input (BCD) OFF: Binary input (BIN)	OFF: Batch input mode (PAC)	0	○									
		1		○								
		2			○							
		3				○						
		4								○		
		5	For factory adjustment (Do not set)									
		6										○
		7 to F	For factory adjustment (Do not set)									
	ON: Dividing input mode (DIV)	0					○				○	○
		1	○					○				
		2							○			
		3					○					
		4		○				○				
		5							○			
		6			○		○					
		7			○			○				
		8							○			
		9					○					
		A				○		○				
B							○					
C to F	For factory adjustment (Do not set)											

How to Read the Input Mode List

Example 1. Switch setting when setting the frequency with a resolution of 1 Hz, via binary input (BIN) in the batch input mode (PAC)

TYPE		CODE
1	2	2
OFF: BIN	OFF: PAC	

Example 2. Switch setting when setting the frequency with a resolution of 0.1 Hz, via BCD input, and setting the acceleration/deceleration time with a resolution of 0.1 sec, via BCD input in the dividing input mode (DIV)

TYPE		CODE
1	2	4
ON: BCD	ON: DIV	

Chapter 3

Functions

3-1	Parameter Description of Each Function.....	3-1
3-2	Type Code.....	3-5
3-3	Data Input Timing.....	3-6

3-1 Parameter Description of Each Function

Binary Batch Input

The settings of frequency, torque limit and position can be selected using the rotary switch (CODE) in a single data input.

The data bit configuration of the binary batch input is shown below.

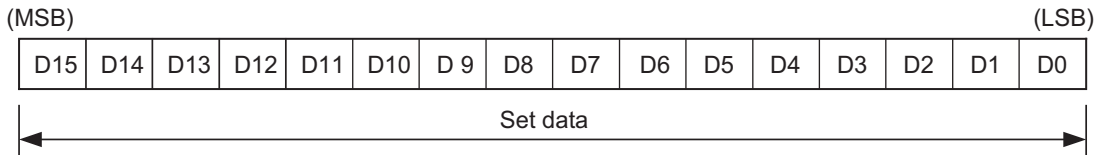

Setting Example

When setting the frequency to 60 Hz with a resolution of 0.1 Hz (Rotary switch setting (CODE): 1)

1. Input the 16-bit binary value of 60 multiplied by 10 in terminals D15 to D0.

$60 \times 10 \text{ times} = 600 \rightarrow 0000001001011000$ (binary)

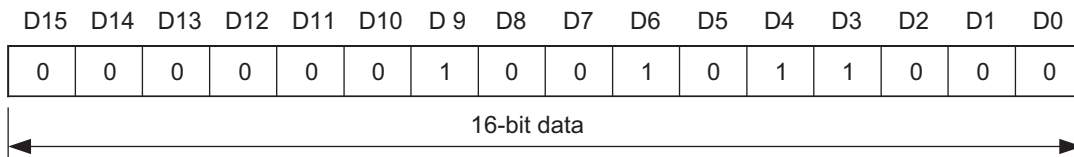

2. When the data is entered, turn the strobe signal ON.

3. Turn the strobe signal OFF.

Precautions

For details on signal input timing, refer to "3-3 Data Input Timing"(Page 3-6).

DIP switch TYPE setting

1	2
OFF: BIN	OFF: PAC

BCD Batch Input

The settings of frequency, torque limit and position can be selected using the rotary switch (CODE) in a single data input.

The data bit configuration of the BCD batch input is shown below.

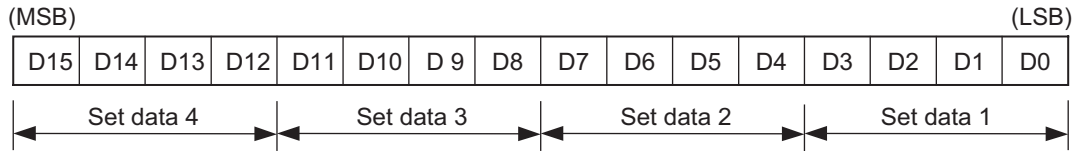

Setting Example

When setting the frequency to 30.00 Hz with a resolution of 0.01 Hz (Rotary switch setting (CODE): 0)

1. Input the 16-bit BCD value of 30 multiplied by 100 in terminals D15 to D0.

$30 \times 100 \text{ times} = 3000 \rightarrow 0011000000000000$ (binary)

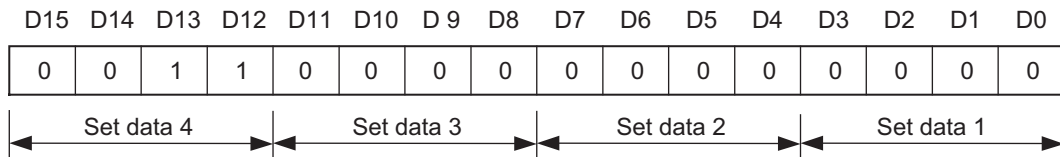

2. When the data is entered, turn the strobe signal ON.

3. Turn the strobe signal OFF.

Precautions

For details on signal input timing, refer to "3-3 Data Input Timing"(Page 3-6).

DIP switch TYPE setting

1	2
ON: BCD	OFF: PAC

Binary Dividing Input

The set data can be changed in two data inputs for MSB and LSB.

In addition, changing the type code enables to change the settings of frequency, torque limit, acceleration/deceleration time, and position (For the type code, refer to "3-2 Type Code"(Page 3-5)).

The set resolution can be selected using the rotary switch (CODE).

The data bit configuration of the binary dividing input is shown below.

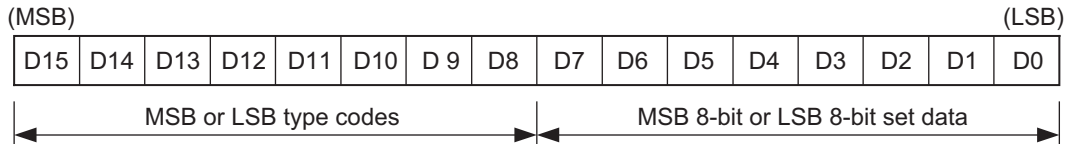

Setting Example

When setting the frequency to a resolution of 0.01 Hz (Rotary switch setting (CODE): 0,1,2)

1. Convert the value of 60 multiplied by 100 into the 16-bit binary value. Next, input the MSB 8 bits in terminals D7 to D0, and input the set frequency MSB code in terminals D15 to D8.

$60 \times 100 \text{ times} = 6000 \rightarrow 0001011101110000$ (binary)

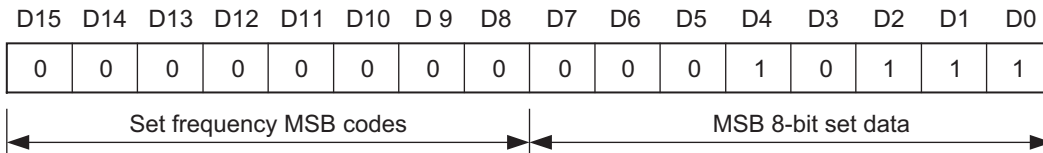

2. When the data is entered, turn the strobe signal ON.
3. Turn the strobe signal OFF.
4. Input the rest of LSB 8 bits in terminals D7 to D0, and input the set frequency LSB code in terminals D15 to D8.

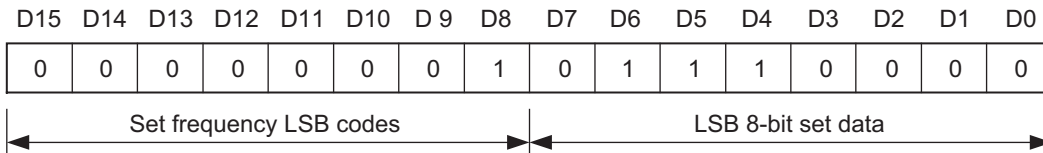

5. When the data is entered, turn the strobe signal ON.
6. Turn the strobe signal OFF.

Precautions

For details on signal input timing, refer to "3-3 Data Input Timing"(Page 3-6).

DIP switch TYPE setting

1	2
OFF: BIN	ON: DIV

BCD Dividing Input

The set data can be changed in two data inputs for MSB and LSB.

In addition, changing the type code enables to change the settings of frequency, torque limit, acceleration/deceleration time, and position (For the type code, refer to "3-2 Type Code"(Page 3-5)).

The set resolution can be selected using the rotary switch (CODE).

The data bit configuration of the BCD dividing input is shown below.

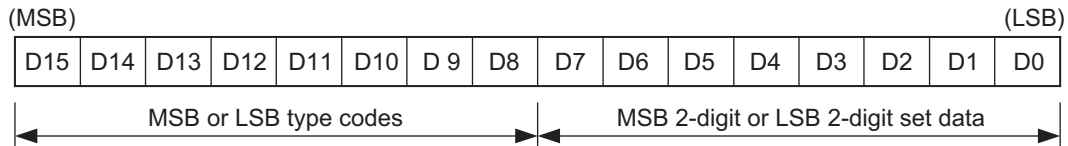

Setting Example

When setting the acceleration time to 60.0 sec with a resolution of 0.1 sec (Rotary switch setting (CODE): 1,4,7,A)

1. Convert the value of 60 multiplied by 10 into the BCD binary value. Next, input the MSB 2 digits in terminals D7 to D0, and input the acceleration time MSB code in terminals D15 to D8.

$60 \times 10 \text{ times} = 600 \rightarrow 0000011000000000$ (binary)

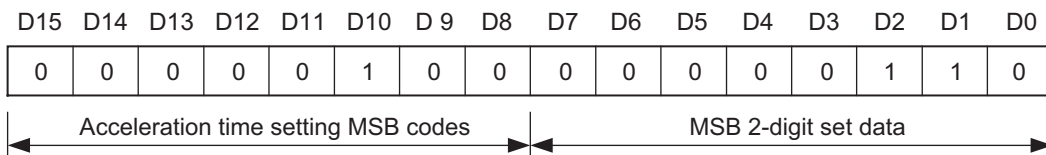

2. When the data is entered, turn the strobe signal ON.

3. Turn the strobe signal OFF.

4. Input the rest of LSB 2 digits in terminals D7 to D0, and input the acceleration time setting LSB code in terminals D15 to D8.

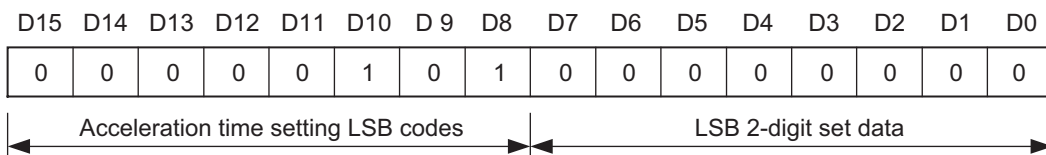

5. When the data is entered, turn the strobe signal ON.

6. Turn the strobe signal OFF.

Precautions

For details on signal input timing, refer to "3-3 Data Input Timing"(Page 3-6).

DIP switch TYPE setting

1	2
ON: BCD	ON: DIV

3-2 Type Code

The type codes when the dividing input mode is set are shown below.
Be sure to input the type codes in the order of MSB to LSB.

Setting item	Type code (D15 to D8)	
	Binary	Hex
Set frequency (MSB)	00000000	0
Set frequency (LSB)	00000001	1
Torque limit setting (MSB)	00000010	2
Torque limit setting (LSB)	00000011	3
Acceleration time setting (MSB)	00000100	4
Acceleration time setting (LSB)	00000101	5
Deceleration time setting (MSB)	00000110	6
Deceleration time setting (LSB)	00000111	7
Position setting (MSB)	00001000	8
Position setting (LSB)	00001001	9

3-3 Data Input Timing

Batch Input Mode Timing

Retrieve the data at the strobe signal ON level.

Set the ON/OFF time for the strobe signal to 20 ms or more. If the data indefinite period exceeds 5 ms, turn the strobe signal OFF according to the following batch data input timing chart.

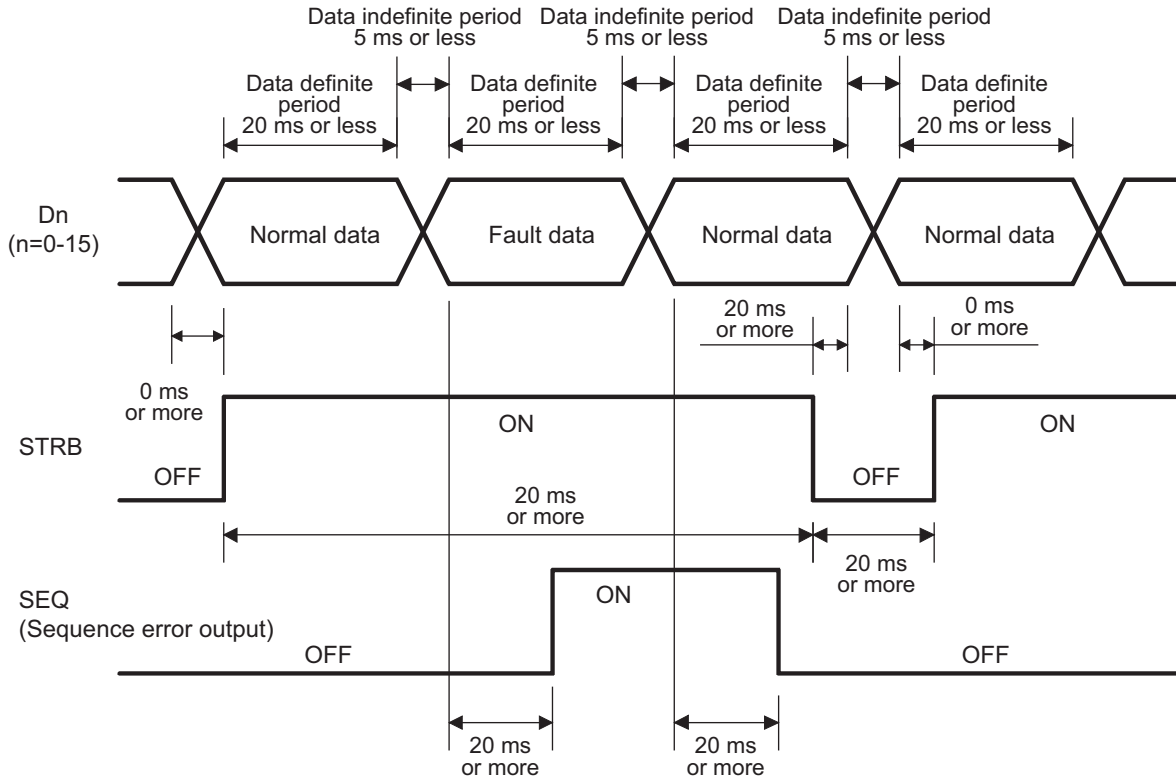

Precautions

Note that wrong data could be retrieved if the data input timing is not based on the above chart.

Dividing Data Input Timing

Retrieve the data at the strobe signal ON edge.
 Set the ON/OFF time for the strobe signal to 20 ms or more.

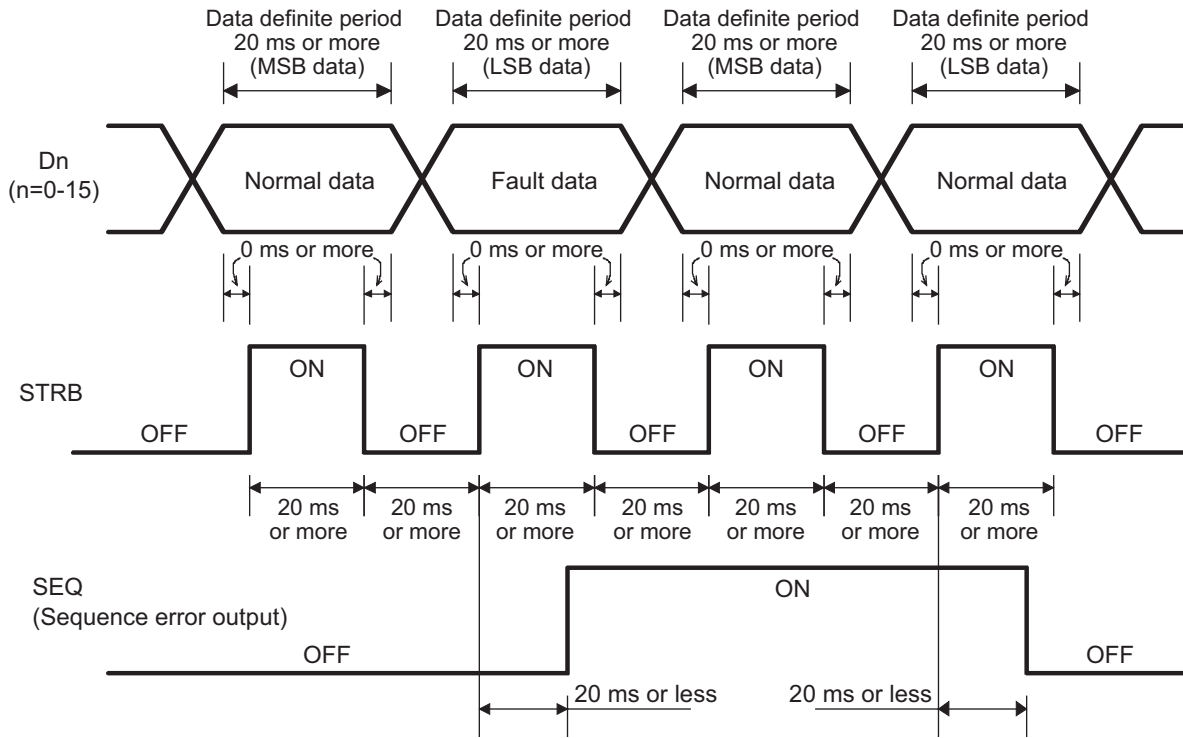

Precautions

Note that wrong data could be retrieved if the data input timing is not based on the above chart.

3
Functions

Chapter 4

Maintenance Operations

4-1	Precautions for Setting the Switches.....	4-1
4-2	Precautions for Data Input	4-2
4-3	Protective Function.....	4-3

4-1 Precautions for Setting the Switches

Precautions for setting the switches are shown below.

- ♦ Shut off the Inverter power and set appropriate settings.
- ♦ When the rotary switch CODE is set to (5,7 to F: for factory adjustment) in the batch input mode, a sequence error is output just after power is supplied to the Inverter.
- ♦ When the rotary switch CODE is set to (C to F: for factory adjustment) in the dividing input mode, a sequence error is output just after power is supplied to the Inverter.

4-2 Precautions for Data Input

Note the following items when inputting the data from the terminals of the 3G3AX-DI Board.

- Each input can be set within the data range of the Inverter for each parameter.
If the data input is out of range, a sequence error will be output, and the data input will be disabled (previous data retained).
- Be sure to input type codes in the order of MSB to LSB in the dividing input mode.
If the LSB code is input first, a sequence error will be output, and the data input will be disabled (previous data retained).
- To reset the sequence error, input a correct data again, reset the Inverter, or shut off the power.
In the dividing input mode, if the two data inputs are correct, the sequence error will be reset just after the second input.
- If a code other than the type code is input, a sequence error will be output
- The data input is disabled when the Inverter trips. Reset the Inverter and input again.
- Do not set each command source of the Inverter (A001, P031, b040, P032) to “Option (1 or 2)” for the port without the DI Board mounted. (Option 1 for Board port 1, 2 for Board port 2)
- Do not mount two DI Boards simultaneously. Doing so may result in malfunction.
- The set values just after each command source of the Inverter (A001, P031, b040, P032) is set to “Option (1 or 2)” are shown below.

Set frequency	0.00[Hz]
Acceleration/Deceleration time	(Set values of the Inverter)
Torque limit setting	0[%]
Position setting	0[pulse]

- To input the set frequency in “rate”, use the following procedure.

Setting example

When setting the frequency in 75% of the maximum frequency, input I_{in} is as follows:

$$I_{in} = 0.75 \times M$$

0.75: Rate

M : Input data full scale

DIP switch TYPE	Input data full scale value (M)
BIN	65535
BCD	9999

Note that f Hz that is actually set is calculated from the following formula:

$$f = \frac{I_{in}}{M} F_{max} \quad F_{max}: \text{Max. frequency Hz}$$



The value ignoring the digit less than 0.001 Hz is used as the set frequency.

4-3 Protective Function

Optional Board Protective Function List

E6*.□(OP1-*) appears when the DI Board is mounted on Board port 1 (Digital Operator connector side) , and E7*.□(OP2-*) appears when it is mounted on Board port 2 (control circuit terminal block side).

The following table shows the protective function and display on the Digital Operator when the DI Board is mounted.

Name	Description	Display on Digital Operator
3G3AX-DI01 error	Shuts off the output and displays an error if a timeout occurs in the communication between the Inverter and the DI Board.	 

Note: Input mode is determined by the combination of the DIP and rotary switches settings. Check the settings of the DIP and rotary switches on the DI Board for any abnormal operation.

OMRON Corporation
Industrial Automation Company
Control Devices Division H.Q.

Motion Control Department
Shiokoji Horikawa, Shimogyo-ku,
Kyoto, 600-8530 Japan
Tel: (81) 75-344-7173/Fax: (81) 75-344-7149
2-2-1 Nishikusatsu, Kusatsu-shi,
Shiga, 525-0035 Japan
Tel: (81) 77-565-5223/Fax: (81) 77-565-5568

Regional Headquarters
OMRON EUROPE B.V.

Wegalaan 67-69-2132 JD Hoofddorp
The Netherlands
Tel: (31)2356-81-300/Fax: (31)2356-81-388

OMRON Industrial Automation Global: www.ia.omron.com

OMRON ELECTRONICS LLC

One Commerce Drive Schaumburg,
IL 60173-5302 U.S.A.
Tel: (1) 847-843-7900/Fax: (1) 847-843-7787

OMRON ASIA PACIFIC PTE. LTD.

No. 438A Alexandra Road # 05-05/08 (Lobby 2),
Alexandra Technopark, Singapore 119967
Tel: (65) 6835-3011/Fax: (65) 6835-2711

OMRON (CHINA) CO., LTD.

Room 2211, Bank of China Tower,
200 Yin Cheng Zhong Road,
PuDong New Area, Shanghai, 200120, China
Tel: (86) 21-5037-2222/Fax: (86) 21-5037-2200

Authorized Distributor:

In the interest of product improvement,
specifications are subject to change without notice.

Cat. No. I565-E1-01