

GOT-A900 Series Operating Manual

(GT Works Version5/GT Designer Version5 compatible
Gateway Functions Manual)

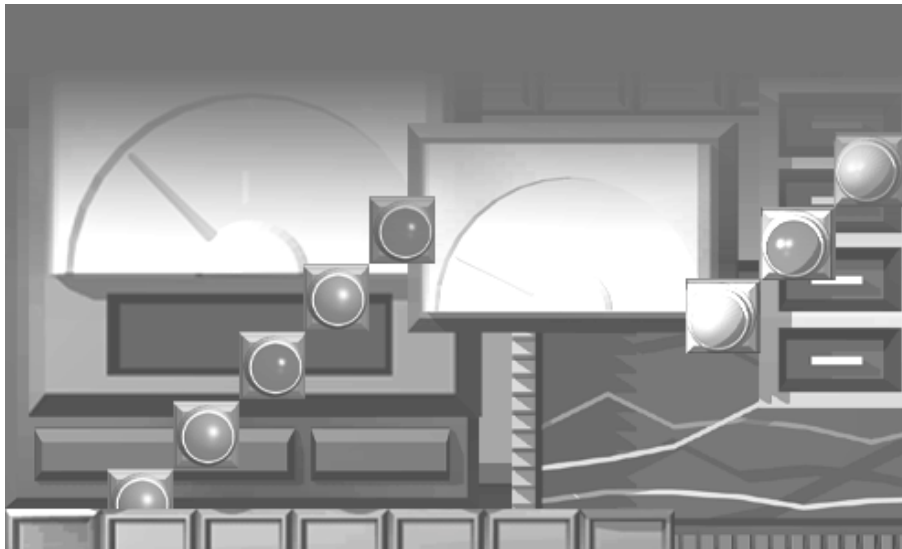

Graphic Operation Terminal
900
series



• SAFETY PRECAUTIONS •

(Always read these instructions before using this equipment.)

Before using this product, please read this manual and the relevant manuals introduced in this manual carefully and pay full attention to safety to handle the product correctly.

The instructions given in this manual are concerned with this product. For the safety instructions of the programmable controller system, please read the CPU module user's manual.

In this manual, the safety instructions are ranked as "DANGER" and "CAUTION".



DANGER

Indicates that incorrect handling may cause hazardous conditions, resulting in death or severe injury.



CAUTION

Indicates that incorrect handling may cause hazardous conditions, resulting in medium or slight personal injury or physical damage.

Note that the  CAUTION level may lead to a serious consequence according to the circumstances. Always follow the instructions of both levels because they are important to personal safety.

Please save this manual to make it accessible when required and always forward it to the end user.

[Precautions for test operation]

CAUTION

- Before starting test operation for system monitor, special function module monitor or ladder monitor (bit device ON/OFF, word device present value changing, timer/counter set value/present value changing, buffer memory present value changing), please read the manual carefully to fully understand the operation methods.
For the devices that perform significant operations for the system, never perform test operation to change data.
Doing so can cause accidents due to false outputs or malfunctions.

REVISIONS

* The manual number is given on the bottom left of the back cover.

Print Date	* Manual Number	Revision
May, 2002	SH (NA)-080254-A	First printing
Jan., 2004	SH (NA)-080254-B	Partial corrections Chapter 4, Section 5.4
Jun., 2004	SH (NA)-080254-C	Partial correction About Manuals MODEL CODE change Changed from 13JU29 to 1DM212

Japanese Manual Version SH-080245-B

This manual confers no industrial property rights or any rights of any other kind, nor does it confer any patent licenses. Mitsubishi Electric Corporation cannot be held responsible for any problems involving industrial property rights which may occur as a result of using the contents noted in this manual.

© 2002 MITSUBISHI ELECTRIC CORPORATION

Structure of This Manual

This manual is made up of the following chapters.

Chapter 1	Overview	Describes the features of the gateway functions.	1
Chapter 2	System Configuration	Describes the system configuration of the gateway functions.	2
Chapter 3	Operation Sequence	Provides the general procedure for using the gateway functions.	3
Chapter 4	Settings Common to Functions	Describes the settings common to the gateway functions.	4
Chapter 5	Server and Client Functions	Describes the specifications, setting methods, precautions and others of the server and client functions.	5
Chapter 6	FTP Server Function	Describes the specifications, setting methods, precautions and others of the FTP server function.	6
Chapter 7	Mail Send Function	Describes the specifications, setting methods, precautions and others of the mail send function.	7
Chapter 8	Troubleshooting	Describes the error messages and troubleshooting for the functions.	8

INTRODUCTION

Thank you for choosing the Mitsubishi Graphic Operation Terminal.
Before using the equipment, please read this manual carefully to use the equipment to its optimum.

CONTENTS

<u>SAFETY PRECAUTIONS</u>	A- 1
<u>REVISIONS</u>	A- 2
<u>Structure of This Manual</u>	A- 3
<u>INTRODUCTION</u>	A- 4
<u>About Manuals</u>	A- 7
<u>About the Generic Terms and Abbreviations</u>	A- 8
<u>About the Symbols</u>	A- 11
1. OVERVIEW	1- 1 to 1- 3
<u>1.1 Features of Server and Client Functions</u>	1- 1
<u>1.2 Features of FTP Server Function</u>	1- 3
<u>1.3 Features of Mail Send Function</u>	1- 3
2. SYSTEM CONFIGURATION	2- 1 to 2- 4
<u>2.1 System Configuration of Gateway Functions</u>	2- 1
<u>2.2 Connection Form</u>	2- 1
<u>2.3 Required Devices</u>	2- 2
<u>2.4 Precautions for Mounting the Communication Board</u>	2- 2
<u>2.5 About the System Programs</u>	2- 4
<u>2.6 Precautions for System Configuration</u>	2- 4
3. OPERATION SEQUENCE	3- 1 to 3- 2
4. FUNCTION SETTING	4- 1 to 4- 4
<u>4.1 GOT Setting</u>	4- 3
<u>4.2 GT Designer Setting</u>	4- 4

5. SERVER AND CLIENT FUNCTIONS 5- 1 to 5-21

5.1 Gateway Devices	5- 1
5.1.1 What are the gateway devices?	5- 1
5.1.2 Usable gateway devices	5- 2
5.1.3 How to monitor the gateway devices	5- 3
5.1.4 PLC devices that can be assigned	5- 6
5.2 Specifications	5- 8
5.2.1 Specifications.....	5- 8
5.2.2 Access range that can be monitored	5- 9
5.3 Setting Method	5-10
5.4 Examples of Use	5-13
5.5 Precautions	5-18
5.6 For Efficient Use	5-19

6. FTP SERVER FUNCTION 6- 1 to 6-13

6.1 Specifications	6- 1
6.1.1 Specifications.....	6- 1
6.1.2 File accessible range.....	6- 2
6.2 Setting Method	6- 3
6.3 Operation on the FTP Client Side	6- 4
6.3.1 Input command at FTP client	6- 4
6.3.2 File specifying method.....	6- 5
6.3.3 Checking the line connection condition	6- 6
6.3.4 Line cutoff	6- 7
6.4 Example of Use	6- 8
6.5 Precautions	6-12

7. MAIL SEND FUNCTION 7- 1 to 7- 8

7.1 Specifications	7- 1
7.1.1 Specifications.....	7- 1
7.1.2 Mail send enabled range.....	7- 2
7.2 Setting Method	7- 3
7.3 Send Examples	7- 4
7.4 Examples of Use	7- 6
7.5 Precautions	7- 8

8. TROUBLESHOOTING

8- 1 to 8-10

8.1 Troubleshooting Common to Gateway Functions	8- 1
8.2 Gateway Information	8- 2
8.3 Server and Client Functions	8- 4
8.3.1 Error codes and error messages	8- 4
8.3.2 Troubleshooting.....	8- 6
8.4 FTP Server Function	8- 7
8.4.1 Error codes and error messages	8- 7
8.4.2 Troubleshooting.....	8- 8
8.5 Mail Send Function	8- 9
8.5.1 Error codes and error messages	8- 9
8.5.2 Troubleshooting.....	8- 9

INDEX

Index- 1 to Index - 2

About Manuals

The following manuals are also related to this product.

In necessary, order them by quoting the details in the tables below.

Related Manuals

Manual Name	Manual Number (Model Code)
GT Works Version5/GT Designer Version5 Reference Manual Explains the specifications, settings and others of the object functions used with GT Designer. (Option)	SH-080117 (1DM187)
GOT-A900 Series Operating Manual (GT Works Version5/GT Designer Version5 compatible Extended • Option Functions Manual) Explains the following extended and optional functions that can be used with the GOT. <ul style="list-style-type: none"> • Utility function • Ladder monitor function • System monitor function • Special function module monitor function • Network monitor function • List editor function • Motion monitor function • Servo amplifier monitor function (Option)	SH-080118 (1DM185)
GOT-A900 Series User's Manual (GT Works Version5/GT Designer Version5 compatible Connection System Manual) Explains the system configuration, cable fabricating method and others of the connection forms that can be used with the GOT-A900 series. (Option)	SH-080119 (1DM189)
A985GOT/A975GOT/A970GOT/A960GOT User's Manual Explains the performance specifications, installation methods, communication board/communication unit mounting methods and others of the GOTs. (Option)	SH-4005 (1DM099)
A950GOT/A951GOT/A953GOT/A956GOT User's Manual Explains the performance specifications, installation methods, communication board/communication unit mounting methods and others of the GOTs. (Option)	SH-080018 (1DM103)
MX Component Version3 Operating Manual Explains the setting and operating methods of the utilities on MX Component. (Option)	SH-080271 (13JU32)
MX Component Version3 Programming Manual Explains the programming procedures, detailed descriptions and error codes of the ACT controls. (Option)	SH-080272 (13JF66)

About the Generic Terms and Abbreviations

The following abbreviations and generic terms are used in this manual.

■ GOT

Generic Term/Abbreviation		Description			
GOT-A900 Series	A985GOT-V	A985GOT-TBA-V,	A985GOT-TBD-V		
	A985GOT	A985GOT-TBA,	A985GOT-TBD,	A985GOT-TBA-EU	
	A975GOT	A975GOT-TBA-B,	A975GOT-TBD-B,	A975GOT-TBA,	A975GOT-TBD,
		A975GOT-TBA-EU			
	A970GOT	A970GOT-TBA-B,	A970GOT-TBD-B,	A970GOT-TBA,	A970GOT-TBD,
		A970GOT-SBA,	A970GOT-SBD,	A970GOT-LBA,	A970GOT-LBD,
		A970GOT-TBA-EU, A970GOT-SBA-EU, A970GOT-LBA-EU			
	A97 * GOT	A975GOT,	A970GOT		
	A960GOT	A960GOT-EBA,	A960GOT-EBD,	A960GOT-EBA-EU	
	A956WGOT	A956WGOT-TBD			
	A956GOT	A956GOT-TBD,	A956GOT-SBD,	A956GOT-LBD,	
		A956GOT-TBD-M3,	A956GOT-SBD-M3,	A956GOT-LBD-M3	
	A953GOT	A953GOT-TBD,	A953GOT-SBD,	A953GOT-LBD,	
		A953GOT-TBD-M3,	A953GOT-SBD-M3,	A953GOT-LBD-M3	
A951GOT	A951GOT-TBD,	A951GOT-SBD,	A951GOT-LBD,		
	A951GOT-TBD-M3,	A951GOT-SBD-M3,	A951GOT-LBD-M3		
A951GOT-Q	A951GOT-QTBD,	A951GOT-QSBD,	A951GOT-QLBD,		
	A951GOT-QTBD-M3,	A951GOT-QSBD-M3,	A951GOT-QLBD-M3		
A950GOT	A950GOT-TBD,	A950GOT-SBD,	A950GOT-LBD,		
	A950GOT-TBD-M3,	A950GOT-SBD-M3,	A950GOT-LBD-M3		
A95 * handy GOT	A950GOT-SBD-M3-H, A950GOT-LBD-M3-H, A953GOT-SBD-M3-H, A953GOT-LBD-M3-H				
A95 * GOT	A956GOT,	A953GOT,	A951GOT,	A951GOT-Q,	
	A950GOT,	A950 handy GOT			

■ Communication board/Communication module

Generic Term/Abbreviation		Description			
Communication board	Bus connection board	A9GT-QBUSS,	A9GT-QBUS2S,	A9GT-BUSS,	A9GT-BUS2S,
	Serial communication board	A9GT-RS4,	A9GT-RS2,	A9GT-RS2T,	A9GT-50WRS2,
Communication module	Ethernet communication module	A9GT-J71E71-T			

■ Option unit

Generic Term/Abbreviation		Description
Option module	Memory card interface module	A1SD59J-MIF

■ Option

Generic Term/Abbreviation		Description			
Option	Memory board	A9GT-FNB, A9GT-FNB8M,	A9GT-FNB1M, A9GT-QFNB,	A9GT-FNB2M, A9GT-QFNB4M,	A9GT-FNB4M, A9GT-QFNB8M
	PC card (memory card)	Abbreviation of the JEIDA Ver. 4.2 compliant (PCMCIA 2.1 compliant) PC card			
	Flash PC card	A9GTMEM-10MF,	A9GTMEM-20MF,	A9GTMEM-40MF	
	Compact flash PC card	Compact Flash™ compliant (Compact Flash™ is the trademark of SunDisk, Inc.)			

■ Software

Generic Term/Abbreviation		Description	
Software	GT Works Version5	SW5D5C-GTWORKS-E	SW5D5C-GTWORKS-EV
	GT Designer Version5	SW5D5C-GOTR-PACKE	SW5D5C-GOTR-PACKEV
	GT Designer	GT Designer screen creation software for GOT900	
	GT Simulator	GT Simulator screen simulator for GOT900	
	GT SoftGOT	GT SoftGOT monitoring software	
	MX Component	MX Component ActiveX communication support tool	

■ CPU





Generic Term/Abbreviation		Description			
QCPU	QCPU (Q mode)	Q00JCPU, Q02HCPU, Q12PHCPU,	Q00CPU, Q06HCPU, Q25PHCPU	Q01CPU, Q12HCPU,	Q02CPU, Q25HCPU,
	QCPU (A mode)	Q02CPU-A,	Q02HCPU-A,	Q06HCPU-A	
QnACPU	QnACPU (Large type)	Q2ACPU, Q4ARCPU	Q2ACPU-S1,	Q3ACPU,	Q4ACPU,
	QnACPU (Small type)	Q2ASCPU,	Q2ASCPU-S1,	Q2ASHCPU,	Q2ASHCPU-S1
ACPU	AnUCPU	A2UCPU,	A2UCPU-S1,	A3UCPU,	A4UCPU
	AnACPU	A2ACPU,	A2ACPU-S1,	A3ACPU	
	AnNCPU	A1NCPU,	A2NCPU,	A2NCPU-S1,	A3NCPU
	ACPU (Large type)	AnUCPU,	AnACPU,	AnNCPU	
	A2US(H)CPU	A2USCPU,	A2USCPU-S1,	A2USHCPU-S1	
	AnS(H)CPU	A1SCPU,	A1SHCPU,	A2SCPU,	A2SHCPU
	A1SJ(H)CPU	A1SJCPU-S3,	A1SJHCPU		
	ACPU (Small type)	A2US(H)CPU,	AnS(H)CPU,	A1SJ(H)CPU	
FXCPU	A1FXCPU	A1FXCPU			
		FX0 series, FX1N series, FX2C series, FX(2N)-10GM/20GM series,	FX0N series, FX1NC series, FX2N series,	FX0s series, FX1s series, FX2NC series,	FX1 series, FX2 series,
Motion controller CPU	Motion controller CPU (A series)	A273UCPU, A172SHCPUN,	A273UHCPU, A173UHCPU,	A273UHCPU-S3, A173UHCPU-S1	A171SHCPUN,
	Motion controller CPU (Q series)	Q172CPU,	Q173CPU		
FA controller		LM610,	LM7600,	LM8000	

■ Third party PLC

Generic Term/Abbreviation		Description			
Omron PLC		C200HS, CQM1, CV1000, CVM1-CPU21,	C200H, C1000H, CV2000, CS1	C200Ha series (C200HX,C200HG,C200HE), C2000H, CVM1-CPU01, CJ1	
Yaskawa PLC		GL60S, GL130, MP-930,	GL60H, CP-9200SH, MP-940,	GL70H, CP-9300MS, MP-9200(H),	GL120, MP-920, PROGIC-8
Allen-Bradley PLC	SLC500 series	SLC500-20, SLC5/02,	SLC500-30, SLC5/03,	SLC500-40, SLC5/04,	SLC5/01, SLC5/05
	MicroLogix1000 series	1761-L10BWA, 1761-L16BWB, 1761-L32BWB, 1761-L20BWA-5A,	1761-L10BWB, 1761-L16BBB, 1761-L32BBB, 1761-L20BWB-5A	1761-L16AWA, 1761-L32AWA, 1761-L32AAA,	1761-L16BWA, 1761-L32BWA, 1761-L20AWA-5A,
	MicroLogix1500 series	1764-LSP			
Sharp PLC		JW-21CU, JW-33CUH,	JW-22CU, JW-50CUH,	JW-31CUH, JW-70CUH,	JW-32CUH, JW-100CUH
Toshiba PLC	PROSEC T series	T3,	T3H,	T2E,	T2N
	PROSEC V series	Model3000			
SIEMENS PLC		SIMATIC S7-300 series,		SIMATIC S7-400 series	
Hitachi PLC (HIDEC H series)	Large type H series	H-302(CPU2-03H), H-702(CPU2-07H), H-4010(CPU3-40H), H-300(CPU-03Ha),		H-1002(CPU2-10H), H-2002(CPU2-20H), H-700(CPU-07Ha), H-2000(CPU-20Ha)	
	H-200 to 252 series	H-200(CPU-02H, CPE-02H), H-252(CPU22-02H), H-252C(CPU22-02HC, CPE22-02HC)		H-250(CPU21-02H), H-252B(CPU22-02HB),	
	H series board type	H-20DR, H-20DT, HL-40DR,	H-28DR, H-28DT, HL-64DR	H-40DR, H-40DT,	H-64DR, H-64DT,
	EH-150 series	EH-CPU104,	EH-CPU208,	EH-CPU308,	EH-CPU316
Matsushita Electric Works PLC		FP0-C16CT, FP2, FP5, FP-M(C32TC)	FP0-C32CT, FP2SH, FP10(S),	FP1-C24C, FP2-CCU, FP10SH,	FP1-C40C, FP3, FP-M(C20TC),

About the Symbols

In this manual, the following symbols are used to represent menus and buttons.

Symbols	Description
[]	Represents the menu item to be selected from the menu bar.
[]	Represents the item in the setting dialog box or the utility menu item of the GOT.
①	Represents the operation sequence, ① to ② to ③.
	Represents the item that provides detailed explanation (manual or the chapter, section or item of that manual).
Point! 	Represents the information that you should know.
 Hint!	Represents the information that will be useful.
 Remark	Represents the supplementary explanation that will be helpful.

1. OVERVIEW

1

This manual explains the gateway functions that can be performed on the GOT-A900 series.

There are the following gateway functions to support remote watching and remote maintenance of production sites from an office.

- Server function
- Client function
- FTP server function
- Mail send function

1.1 Features of Server and Client Functions

1 Collection of data by personal computer (server function)

Monitoring the GOTs (servers) from the personal computer (MX Component) allows data to be read/written indirectly from/to the PLC CPU devices being monitored by the GOTs.

If the PLC CPU of a different maker is monitored, use of the server function enables data to be read/written with only MX Component and the communication method to be standardized by Ethernet.

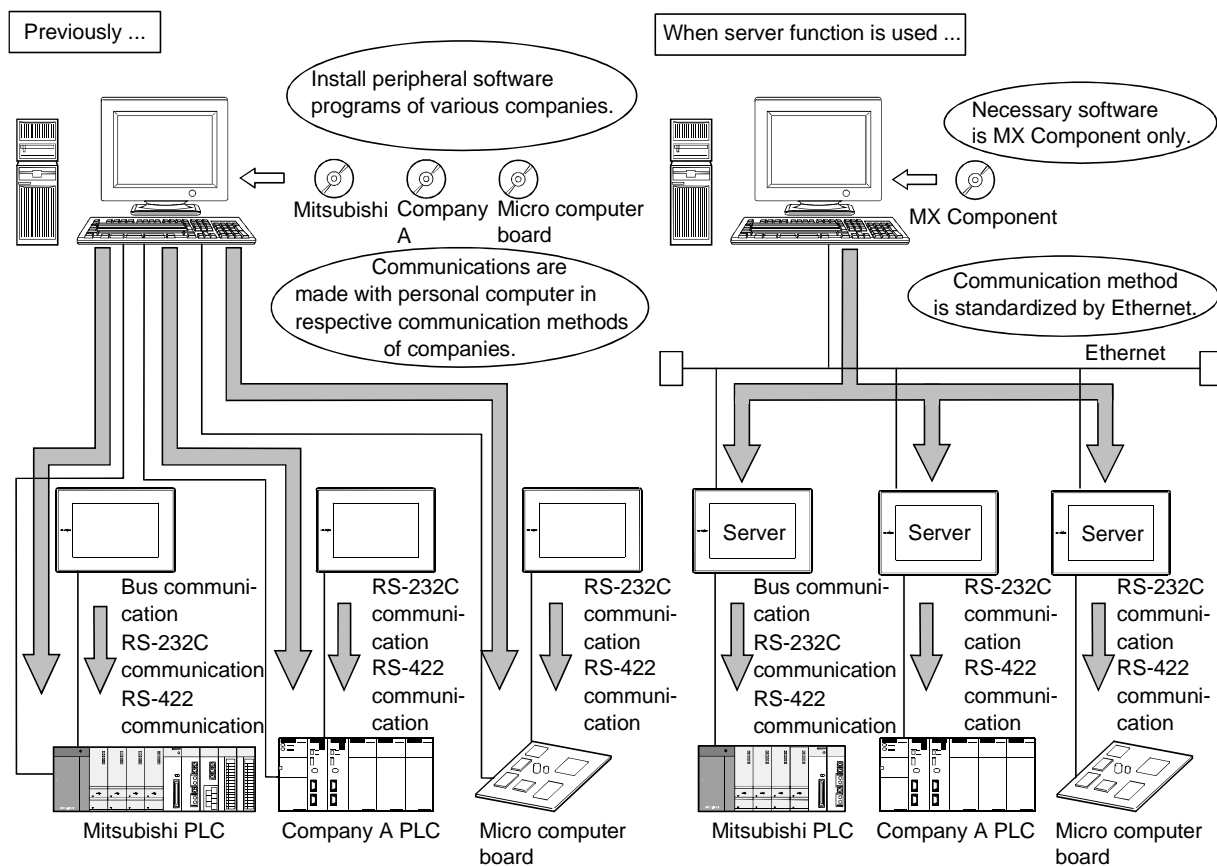

2 Monitoring of other GOTs from client GOT (server function, client function)

Monitoring of the GOTs (servers) from the GOT (client) allows data to be read/written indirectly from/to the PLC CPU devices being monitored by the GOTs (servers).

Use of the client function enables data to be read/written indirectly from/to the PLC CPUs of different makers that are different from the maker of the PLC CPU connected to the GOT (client).

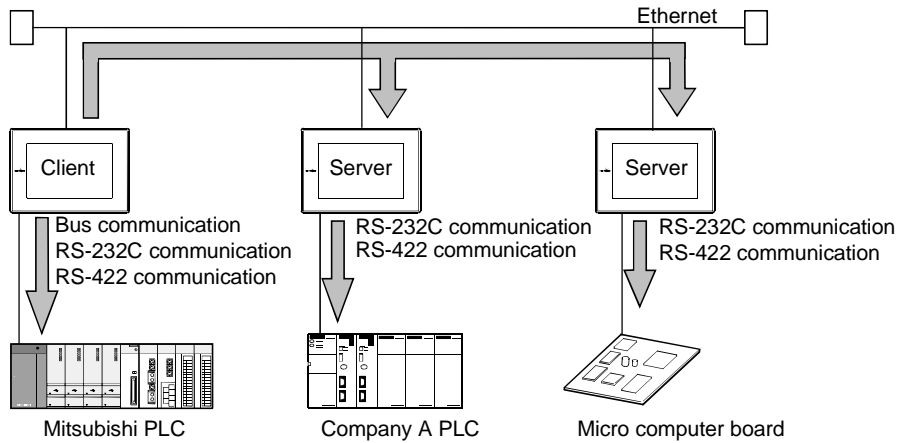

1.2 Features of FTP Server Function

Using the FTP server function, you can read/write data (recipe, alarm history, screen image data) saved in the PC cards of the GOTs from the personal computer.

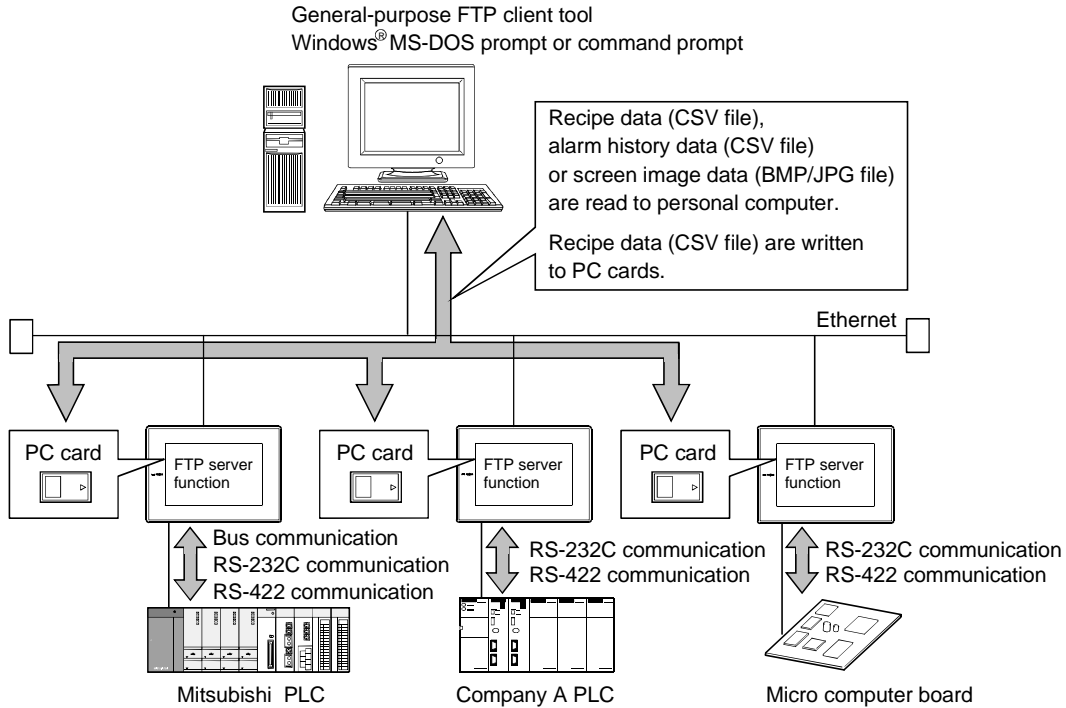

1.3 Features of Mail Send Function

Using the alarm history display function, you can send the occurrence or restoration information of an error to the personal computer or cellular phone by mail at occurrence of or restoration from the error.

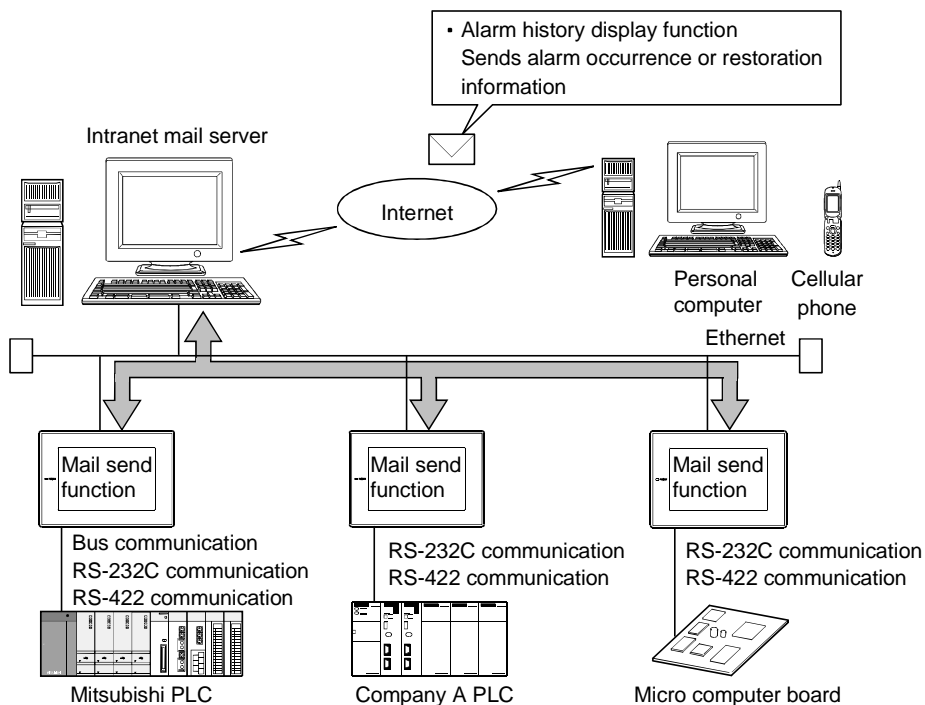

2. SYSTEM CONFIGURATION

This chapter describes the system configuration of the gateway functions.

2.1 System Configuration of Gateway Functions

When the gateway functions are used, one GOT connects to Ethernet and PLCs and therefore both the Ethernet communication module and communication board must be mounted to the GOT. Hence, the gateway functions cannot be used for the GOT that cannot be mounted with the Ethernet communication module and for the connection form that uses the communication module.

(Example 1) For A951GOT

Since the Ethernet communication module cannot be mounted, the gateway functions cannot be used.

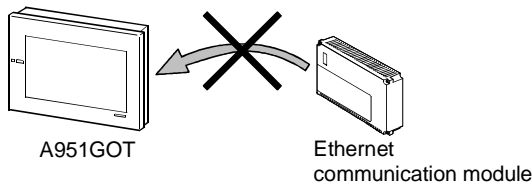

(Example 2) For CC-Link connection

Since two different communication modules cannot be mounted to one GOT, the gateway functions cannot be used.

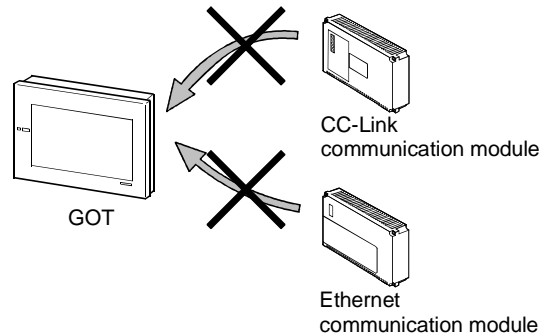

2.2 Connection Form

The GOTs that can use the gateway functions are indicated on a connection form basis. Refer to the following manual for details of the connection forms.

GOT-A900 Series User's Manual (GT Works Version5/GT Designer Version5 compatible Connection System Manual)

○ : Usable × : Unusable - : Not connectable

Connection Form	A985 GOT(-V)	A97□ GOT	A960GOT	A956W GOT	A956GOT -M3 ^{*1*2}	A953GOT	A951GOT (-Q)	A950GOT	A95□ handy GOT	GT SoftGOT
Bus connection	○	○	○	○	○	-	×	-	-	-
CPU direct connection	○	○	○	○	-	×	-	×	×	×
Computer link connection	○	○	○	○	-	×	-	×	×	×
MELSECNET connection	×	×	×	×	×	-	-	-	-	-
CC-Link connection	×	×	×	×	×	-	-	-	-	-
Ethernet connection	×	×	×	×	×	-	-	-	-	×
Third party PLC connection	○	○	○	○	-	×	-	×	×	-
Microcomputer connection	○	○	○	○	-	×	-	×	×	-

* 1 When using the A956GOT, use the memory extension type (A956GOT-TBD-M3, A956GOT-SBD-M3, A956GOT-LBD-M3) GOT.

* 2 Unable to make RS-232C/RS-422 communication, the A956GOT cannot be connected with the FXCPU or third-party PLC.

2.3 Required Devices

The following devices of the GOTs are required to use the gateway functions.

Application	Required Device	A985GOT (-V)	A97□GOT	A960GOT	A956WGOT	A956GOT -M3
Connects GOT to Ethernet system.	Ethernet communication module	A9GT-J71E71-T (Hardware version E (June, 2002) or later) *1				
Connects GOT to PLC.	Communication board	Bus connection (QCPU (Q mode))	A9GT-QBUSS or A9GT-QBUS2S *2, *3			
		Bus connection (QnA/ACPU)	A9GT-BUSS or A9GT-BUS2S *2, *3			
		RS-232C communication	A9GT-RS2 or A9GT-RS2T	A9GT-50WRS2	Cannot be connected.	
		RS-422 communication	A9GT-RS4	A9GT-50WRS4		
Executes gateway functions with GOT.	Memory board	A9GT-QFNB (4/8M) or A9GT-FNB (1/2/4/8M)				Not required
Required to use FTP server function.	PC card	JEIDA Ver. 4.2 compliant (PCMCIA 2.1 compliant) PC card *4				
	Flash PC card	A9GTMEM-10MF, A9GTMEM-20MF, A9GTMEM-40MF	Cannot be used.			
	Compact flash PC card	Compact Flash™ compliant compact flash PC card *5				Cannot be used.

*1 The gateway functions cannot be used with the hardware version D or earlier.

*2 The bus connection module (A9GT-BUSSU, A9GT-BUS2SU, A9GT-QBUS2SU) cannot be used for the gateway functions.

Use the above bus connection board when making bus connection.

*3 The bus connection board (A9GT-50WQBUSS, A9GT-50WBUSS) dedicated to the A956WGOT cannot be used for the gateway functions.

Use the above bus connection board when making bus connection with the A956WGOT.

*4 The memory card interface module is required to use the PC card with the A956WGOT or A956GOT.

*5 The A985GOT cannot use the compact flash PC card. (It can be used with the A985GOT-V only.)

2.4 Precautions for Mounting the Communication Board

How to mount the communication board to the GOT changes depending on the communication board used. The precautions for mounting the communication board are described below.



About the mounting of the communication board

Do not mount both the bus connection board and serial communication board to the GOT.

1 When using the serial communication board

When mounting the serial communication board, mount it to the GOT as previously. Refer to the following manual for the way to mount the communication board.



- A985GOT/A975GOT/A970GOT/A960GOT User's Manual
- A950GOT/A951GOT/A953GOT/A956GOT User's Manual

2 When using the bus connection board

Mount the bus connection board to the back of the A9GT-J71E71-T.
How to mount the bus connection board is shown below.

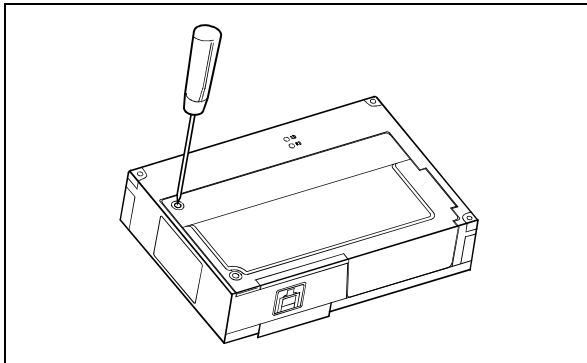

- 1) Loosen the mounting screws (2 pcs.) that fix the slot cover on the back of the A9GT-J71E71-T.

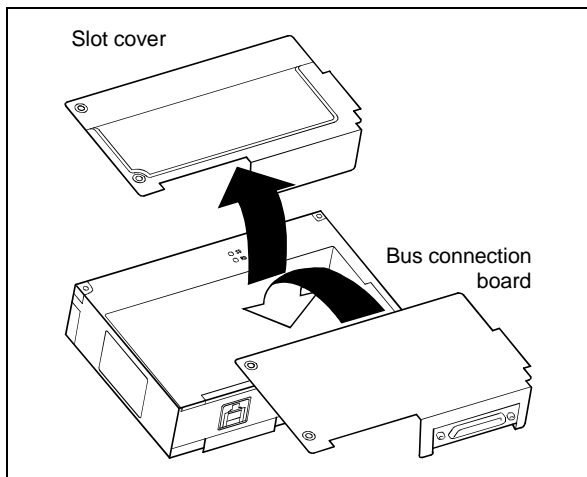

- 2) Remove the slot cover.
Save the removed slot cover carefully.
(If the A9GT-J71E71-T is used alone without the slot cover, foreign matter will enter the unit, causing a failure or malfunction.)
- 3) Fit the bus connection board to the A9GT-J71E71-T.

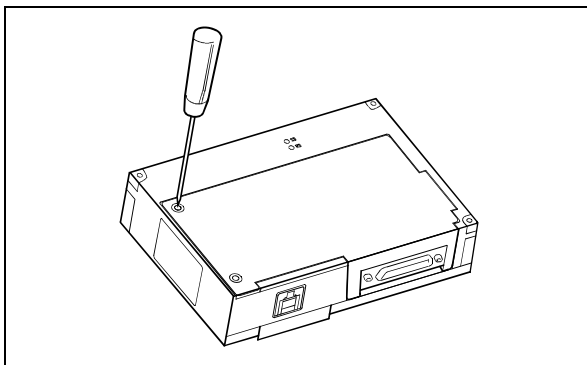

- 4) Tighten the mounting screws (2 pcs.) of the bus connection board to the specified torque (36 to 48N • cm) to fix the bus connection board.
- 5) After fitting the bus connection board, mount the A9GT-J71E71-T to the GOT.

2.5 About the System Programs

The system programs compatible with the GOT must have been installed to use the gateway functions. Refer to the following manual for the system programs necessary for the gateway functions, their installation methods and precautions.

 • GT Works Version5/GT Designer Version5 Reference Manual

2.6 Precautions for System Configuration

1 Connection to the intranet must be fully safeguarded.

Consult the network access provider or network manager (person who does network planning, IP address management, etc.).

We have no liability for any system problems that occur at the time of connection to the intranet.

2 If a delay occurs due to network congestion, take preventive measures, e.g. install a bridge.

3. OPERATION SEQUENCE

A general procedure for using the gateway functions is given below.

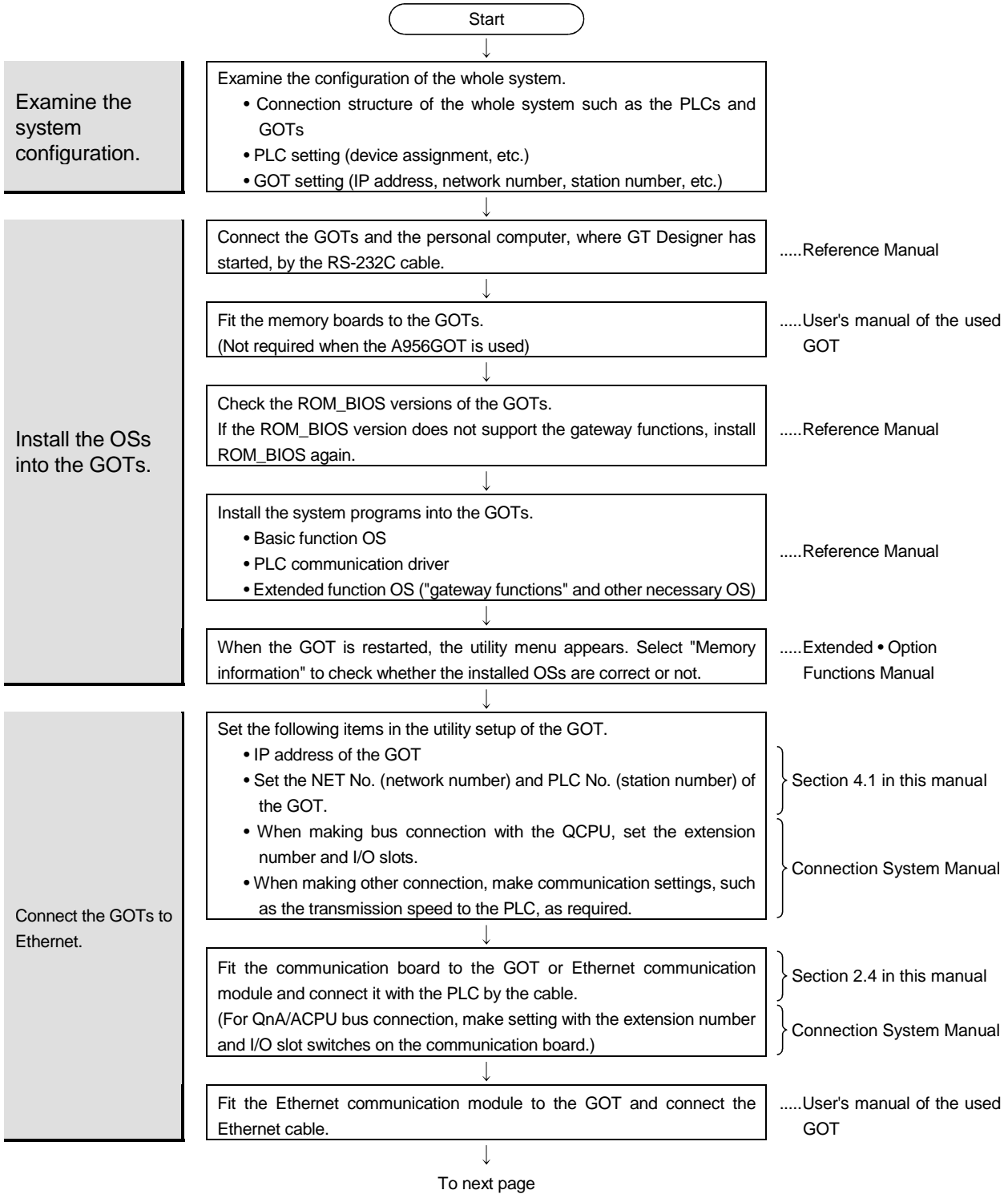

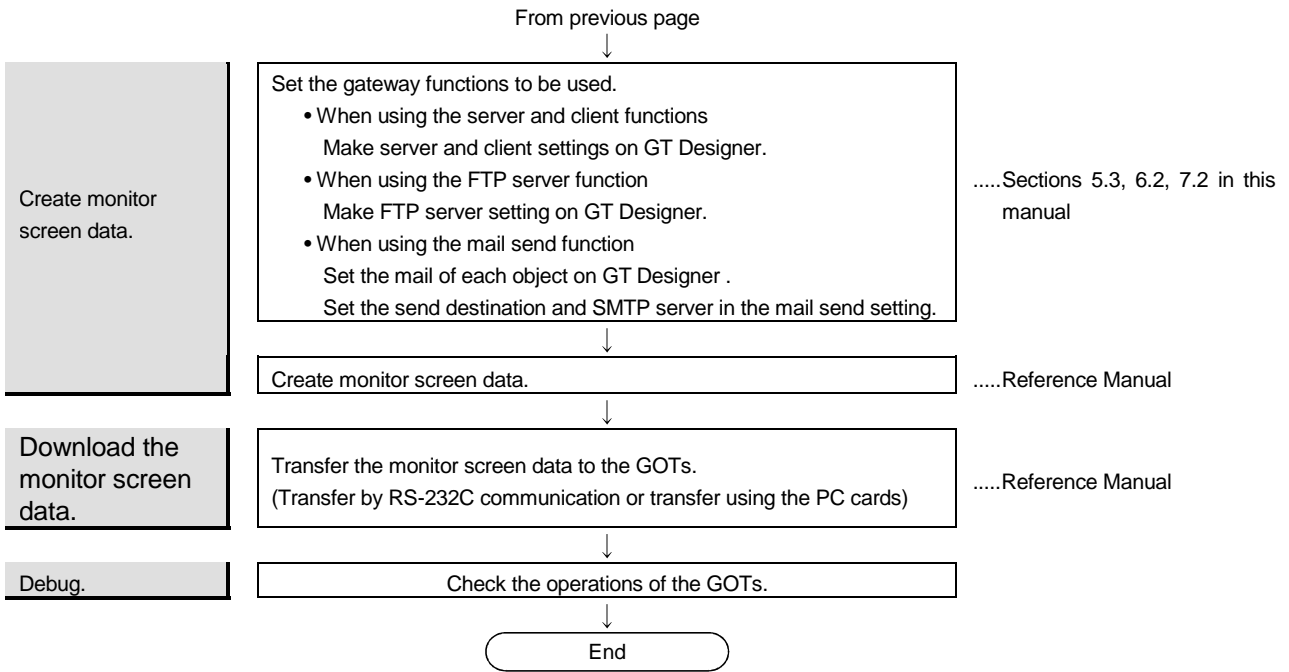

4. FUNCTION SETTING

To use the gateway functions, settings related to the gateway functions must be made on both the GOT and GT Designer.

Settings to be made on the GOT and GT Designer will be described below.

1 Server and client functions

<System configuration example>

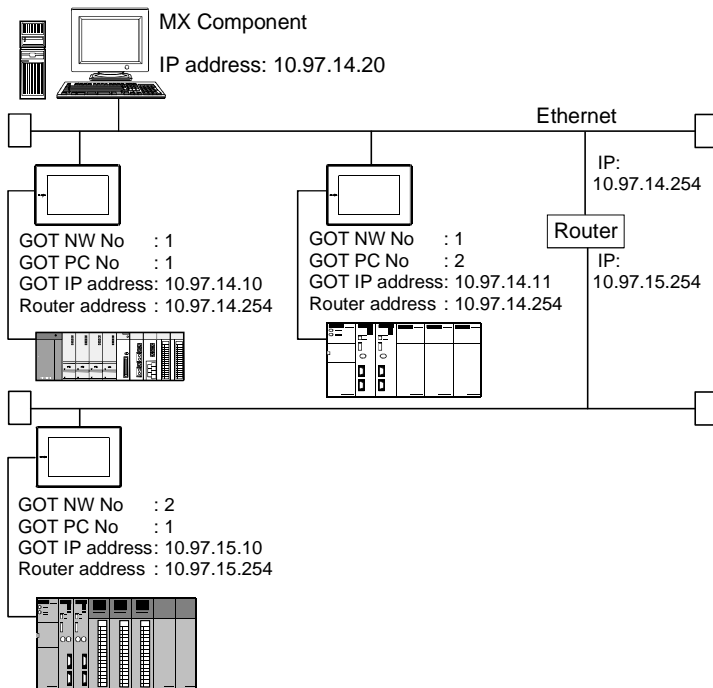

- Utility menu of the GOT (Refer to Section 4.1.)
Set the network No., station number, IP address, etc. of the GOT itself on each GOT.

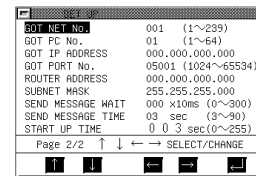

- GT Designer (Refer to Section 5.3.)
<Server setting>
Setting of the server function to the GOT.
Assign the PLC CPU devices to the gateway devices to be accessed by MX Component and the GOT of the client function.

EG Device	Device	Type	Points
1	EG0	0-FF	0B160
2	EG2	0-FF	D100

- <Client setting>
Setting of the client function to the GOT.
Register its the network No., PLC No. and IP addresses of the GOTs of the server function to be accessed.

N/W No.	PLC No.	Type	IP address	Port No.	Communication
1	1	2	GOT	F097142	B011
2	1	3	GOT	F097143	B011
3					

2 FTP server function

<System configuration example>

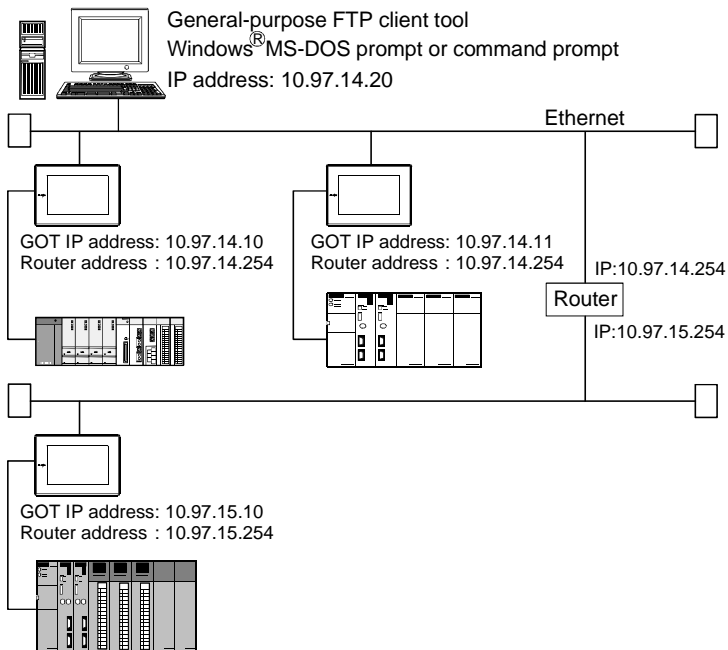

- Utility menu of the GOT (Refer to Section 4.1.)
Set the IP address of the GOT itself on each GOT.

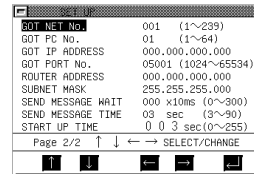

- GT Designer (Refer to Section 6.2.)
<FTP server setting>
Set the login name and password used for connection of the line of the personal computer and GOT.

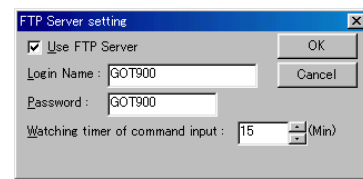

4

3 Mail send function

<System configuration example>

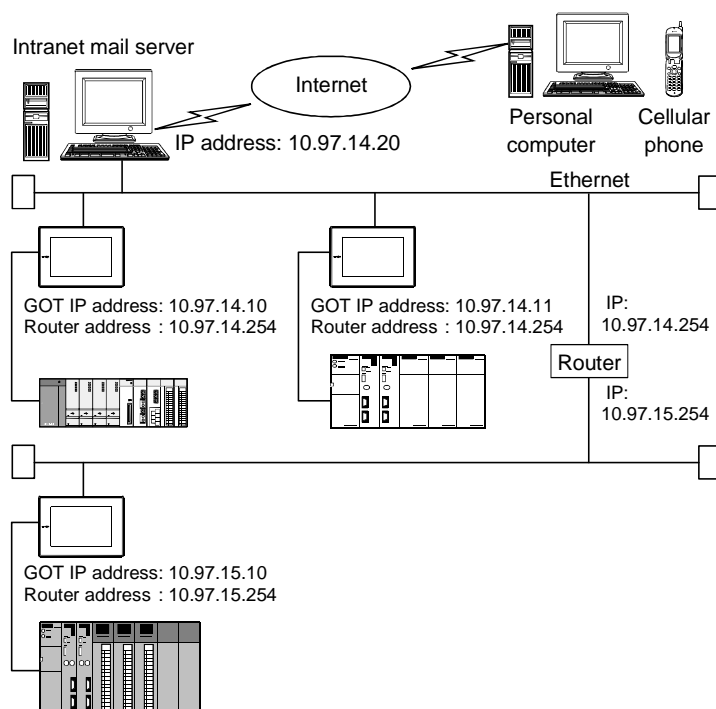

- Utility menu of the GOT (Refer to Section 4.1.)
Set the IP address and mail sending of the GOT itself on each GOT.

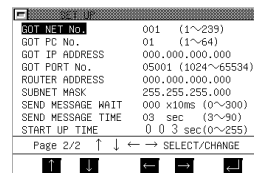

- GT Designer (Refer to Section 7.2.)
<Mail send setting>
Specify the mail server and set the mail address and others of the send destination.

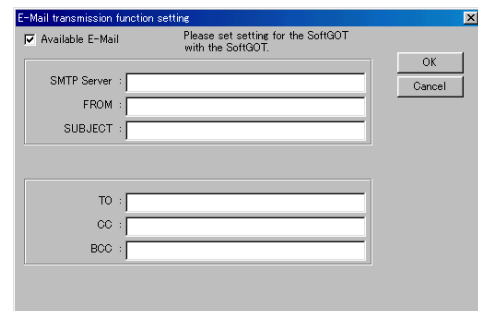

4.1 GOT Setting

Perform the GOT setting in the setup of the utility menu.

Installing the gateway option driver into the GOT or fitting the A9GT-J71E71-T to the GOT displays the following menu. Make the necessary settings.

The settings to be made change depending on the gateway functions used.

Refer to the following manual for the way to operate the utility menu.

 GOT-A900 Series Operating Manual (GT Works Version5/GT Designer Version5 compatible Extended • Option Functions Manual)

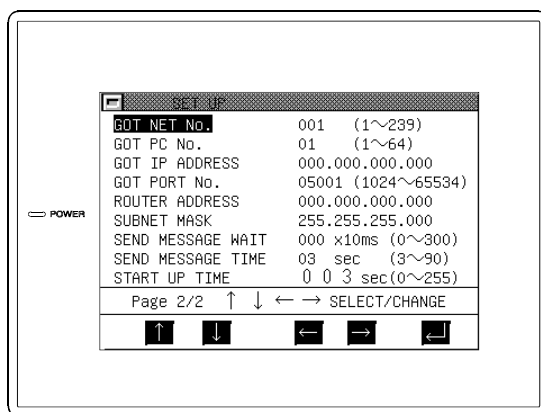

◎: Setting required ○: Setting required depending on condition —: Setting not required (no problem will arise if setting is made)

Setting Item	Description	Factory Setting	Server Function	Client Function	FTP Server Function	Mail Send Function
GOT NET NO.	Set the network No. of the GOT.	1	◎	◎	—	—
GOT PC NO.	Set the station number of the GOT.	1	◎	◎	—	—
GOT IP ADDRESS * 1	Set the IP address of the GOT.	000.000.000.000	◎	◎	◎	◎
GOT PORT NO.	Set the port No. of the GOT.	5001	—	—	—	—
ROUTER ADDRESS * 2	When the system is connected to the other network by a router, set the router address of the network where the GOT is connected.	000.000.000.000	○	○	○	○
SUBNET MASK * 2	When the GOT is connected to the Ethernet network under control of the subnet, set the subnet mask set commonly to the networks. When the subnet is not used, the default value is used for operation.	255.255.255.000	○	○	○	○
SEND MESSAGE WAIT	Set the send message wait to reduce the loads of the network and target PLC.	0	—	—	—	◎ * 3
SEND MESSAGE TIME	Set the message time.	3	◎	◎	—	◎ * 4
START UP TIME	Set when to start communication (in seconds) after power-on of the GOT.	3	—	◎	—	◎

*1 Set the IP address after consulting the network manager (person who does network planning, IP address management, etc.).

*2 Before setting the values, have them checked by the network manager.

*3 When sending multiple mails, set the time interval from when one mail is sent until the next mail is sent.

*4 The send message time for connection with the SMTP server at the start of mail sending has been set to 1 minute (fixed).

Set the send message time after connection of the SMTP server.

4.2 GT Designer Setting

Set the gateway functions in the gateway setting of GT Designer.

For the settings, refer to the setting methods of the corresponding functions.

- When using the server and client functions



Section 5.3 Setting Method

- When using the FTP server function



Section 6.2 Setting Method

- When using the mail send function



Section 7.2 Setting Method

5. SERVER AND CLIENT FUNCTIONS

This chapter explains the server and client functions.

5.1 Gateway Devices

5.1.1 What are the gateway devices?

The gateway devices are virtual devices designed exclusively to perform the server and client functions on the GOT, and the PLC CPU devices and GOT's internal devices are assigned to the gateway devices for use.

1 When accessing the PLC from the personal computer via the GOT

Accessing the gateway devices of the GOTs (server function) from the personal computer enables indirect access to the PLC CPU devices.

5

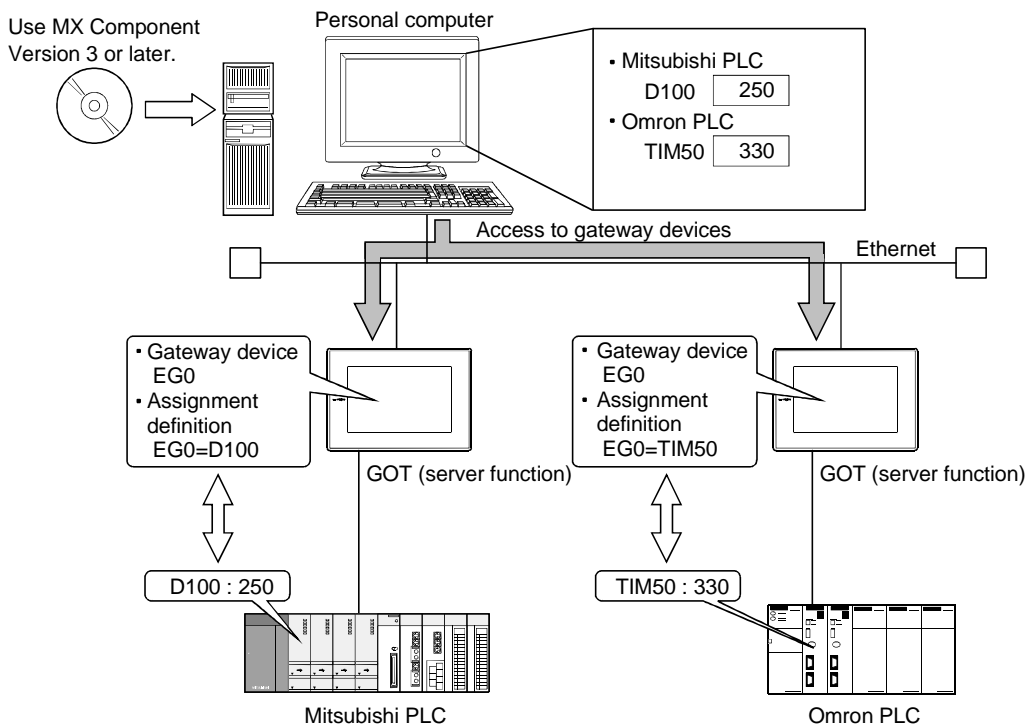

Refer to the following for the devices required for the GOT.

 Section 2.3 Required Devices

2 When monitoring the PLC of different maker from one GOT

Accessing the gateway device of the GOT (server function) from the GOT (client function) enables indirect access to the PLC CPU device.

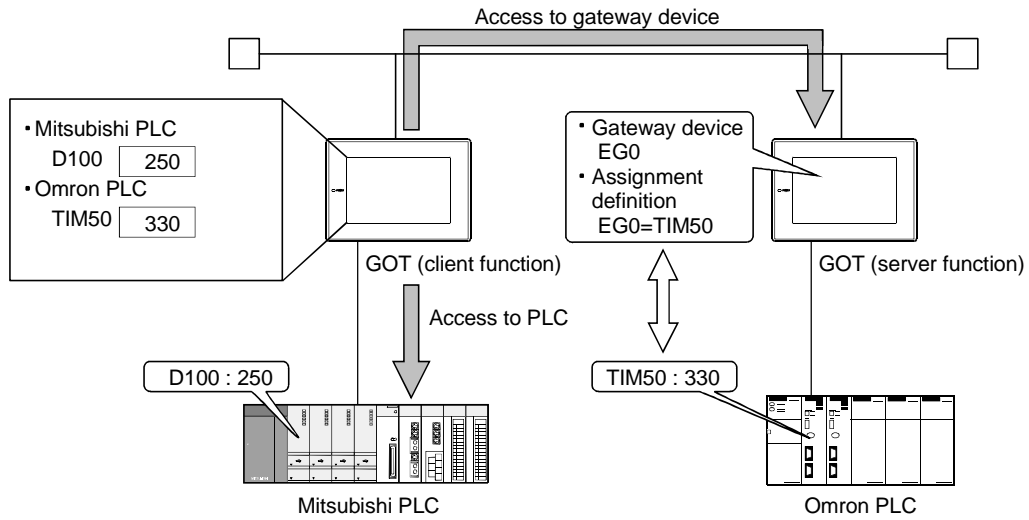

5

5.1.2 Usable gateway devices

The usable gateway devices are indicated below.

Device Name		Device Range	Device Number Representation	Max. Number of Points
Word device	EG	EG0 to EG32767	Decimal	32k points
Bit device	EG	Specified bits of above word devices	Decimal	—

5.1.3 How to monitor the gateway devices

1 When accessing the gateway devices from the personal computer

Using the functions of MX Component (e.g. Microsoft® Excel), access the gateway devices of the GOTs.

Refer to the following manuals for the operation method and programming procedure of MX Component.



- MX Component Operating Manual
- MX Component Programming Manual

The following functions of MX Component are compatible with the GOT.

Item	Description
Open	Opens the communication line (starts communication with the GOT).
Close	Closes the communication line (ends communication with the GOT).
ReadDeviceBlock	Batch-reads data from devices.
ReadDeviceBlock2	
WriteDeviceBlock	Batch-writes data to devices.
WriteDeviceBlock2	
ReadDeviceRandom	Randomly reads data from devices.
ReadDeviceRandom2	
WriteDeviceRandom	Randomly writes data to devices.
WriteDeviceRandom2	
EntryDeviceStatus	Registers device status watching.
FreeDeviceStatus	Cancels registering device status watching.
OnDeviceStatus	Announces event.
SetDevice	Changes the device data values.
SetDevice2	
GetDevice	Gets the device data values.
GetDevice2	
GetCpuType	Gets the GOT model.

2 When accessing the gateway device from the GOT

The gateway devices cannot be assigned to the object functions.
Hence, the script function is used to monitor them.

The following explains the setting example for access to the gateway device from the GOT.

(1) When reading the gateway device value

Using the script function, read the gateway device value of the GOT (server function) to the internal device of the GOT (client function).

By monitoring the value read to the internal device using the numerical display function or like, the GOT (client function) can monitor the same value as the gateway device value of the GOT (server function).

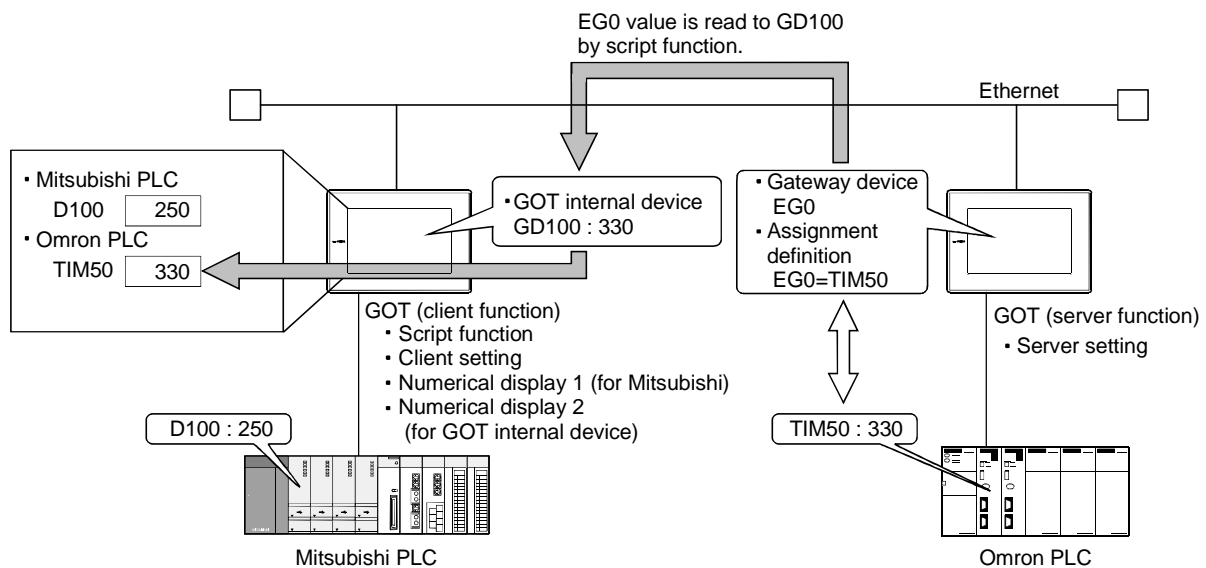

*The read destination of the script function can be set to the device of the Mitsubishi Electric PLC.

(a) Setting items of the GOT (client function)

- Script functionMake setting to read the gateway device value of the GOT (server function) to the internal device of the GOT (client function).
- Client settingRegister the GOT of the server function whose device value will be read.
- Numerical display 1 function....Make setting to display the device value of the Mitsubishi Electric PLC.
- Numerical display 2 functionMake setting to display the internal device value of the GOT (client function).

(b) Setting item of the GOT (server function)

- Server setting.....Make setting to assign the device of the Omron PLC to the gateway device.

(2) When writing a value to the gateway device

Using the numerical input function or like, write a value to the gateway device of the GOT (client function).

Using the script function, write the internal device value of the GOT (client function) the gateway device of the GOT (server function).

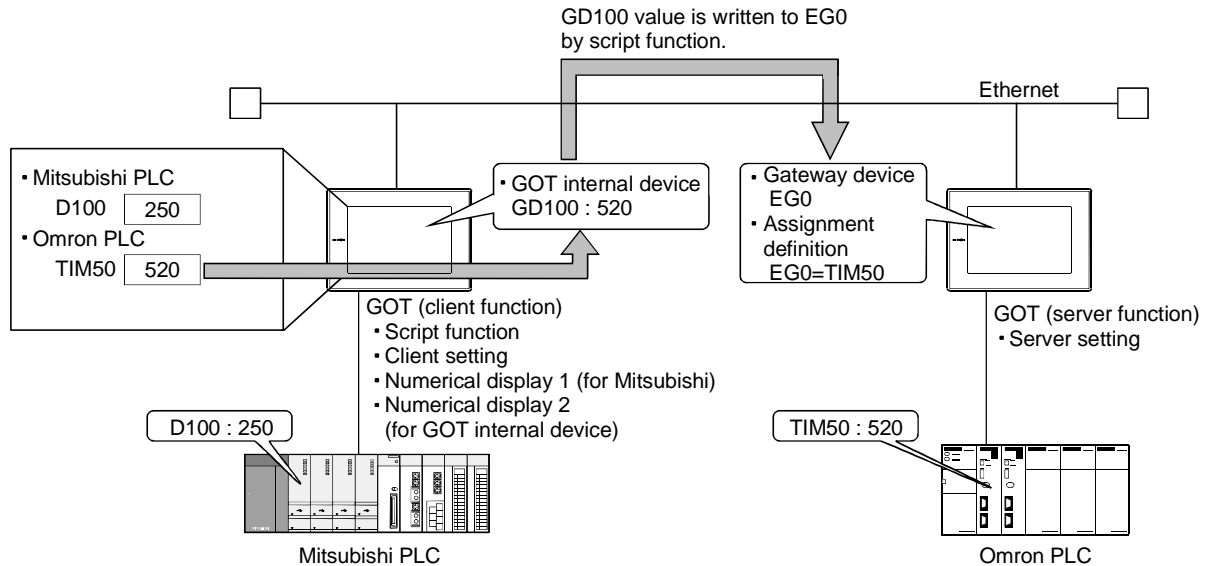

*The write destination of the script function can be set to the GOT internal device of the sever function.

(a) Setting items of the GOT (client function)

- Script functionMake setting to write the internal device value of the GOT (client function) to the gateway device of the GOT (server function).
- Client settingRegister the GOT of the server function where the value will be written.
- Numerical input 1 functionMake setting to input a value to the device of the Mitsubishi Electric PLC.
- Numerical input 2 functionMake setting to input a value to the internal device of the GOT (client function).

(b) Setting item of the GOT (server function)

- Server settingMake setting to assign the device of the Omron PLC to the gateway device.



About details of the script function

Refer to the following manual for details of the script function.



GT Works Version5/GT Designer Version5 Reference Manual

For the examples using the script function, refer to Section 5.4 of this manual.

5.1.4 PLC devices that can be assigned

1 PLC devices that can be assigned

The PLC PCU devices that can be monitored by the GOT and the GOT internal devices can be assigned to the gateway devices.

Refer to the following manual for the devices that can be monitored by the GOT.

 GT Works Version5/GT Designer Version5 Reference Manual

2 Precautions for monitoring the gateway devices

When the following PLC CPU devices are assigned to the gateway devices, they cannot be monitored depending on the used script function commands or MX Component functions.

The restricted commands/functions are indicated on a PLC CPU basis.

○: No restrictions △: Some devices cannot be used (unusable device names are indicated in parentheses)

Maker Name		Restricted Script Function Commands			Restricted MX Component Functions		
		bmov, fmov instruction	Word device-specified	Bit device-specified	ReadDevice Block	ReadDeviceRandom WriteDeviceRandom	
						Word device-specified	Bit device-specified
Mitsubishi Electric	Q/QnA/A/FX CPU, motion controller A series	○	△ (TT, TC, CT, CC)	△ (Z, BM)	○	△ (TT, TC, CT, CC)	△ (Z, BM)
	Motion controller Q series	○	○	○	○	○	○
Allen-Bradley PLC		△ (TT, TN, CU, CD, CN, TP, TA, CP, CA)	△ (TT, TN, CU, CD, CN)	○	△ (TT, TN, CU, CD, CN, TP, TA, CP, CA)	△ (TT, TN, CU, CD, CN)	○
Omron PLC		○	○	○	○	○	○
Sharp PLC		△ (T, C)	△ (T, C)	○	△ (T, C)	△ (T, C)	○
Yaskawa PLC		○	○	○	○	○	○
Toshiba PLC		○	△ (Z, T, C)	○	○	△ (Z, T, C)	○
Hitachi PLC		○	△ (TD, SS, WDT, MS, TMR, CU, RCU, CT, R, DIF, DFN)	○	○	△ (TD, SS, WDT, MS, TMR, CU, RCU, CT, R, DIF, DFN)	○
Matsushita Electric Works PLC		○	△ (T, C)	○	○	△ (T, C)	○
SIEMENS PLC		○	○	○	○	○	○

(Example) When the bmov instruction is used with the script function
The gateway device to which TT (Allen-Bradley PLC device) has been assigned cannot be monitored.

* 1 The devices not indicated in the above table can be monitored.

* 2 Can be monitored if the bit device-specified command is used.

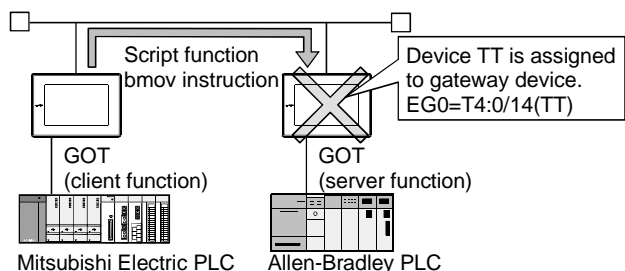



Remark

Restricted script function commands

There are restrictions on the following script function commands.
Refer to the following manual for details of the commands.



GT Works Version5/GT Designer Version5 Reference Manual

• Word device-specified command names

Item	Description	
Function	Applied arithmetic operation	sin, cos, tan, asin, acos, atan, abs, log, log10, exp, ldexp, sqrt

• Bit device-specified command names

Item	Description	
Operator	Bit device	&, , ~, ^, <<, >>
	Substitution	=
	Device operation	set, rst, alt

5.2 Specifications

5.2.1 Specifications

The specifications of the server and client functions are given below.

Item		Specifications	Setting Method
Port number	Server function	5011	Fixed
	Client function	5012, 5013	
Max. number of nodes		Recommended: Max. 64 units (GOT (server function) + GOT (client function) + personal computer that communicates with GOTs = 64 units)	—
Number of clients (GOT, personal computer) that can access servers (GOTs) simultaneously		Max. 5 units * 1	—
Other node designation		IP address designation, max. 128 units	GT Designer
Gateway device		32k points of word devices: EG0 to 32767	
Compatible MX Component		MX Component Version 3 (SW3D5C-ACT(-A)) or later	—
Memory space used by GOT (bytes)	Server function	20 + 20 × number of assigned gateway device points	GT Designer
	Client function	16 + 20 × preset number of GOTs of server function	

* 1 If six or more clients (GOT, personal computer) make simultaneous access to the servers (GOTs), the scripts of the clients may stop.

5.2.2 Access range that can be monitored

The access range of the server and client functions is shown below.

When the PLC CPU is monitored via the GOT, only the PLC CPU device set to the gateway device of the GOT can be accessed.

- The device of the PLC CPU as the network destination can be monitored when it is assigned to the gateway device of the GOT connected.
- The GOT cannot monitor the PLC CPU of Ethernet connection.

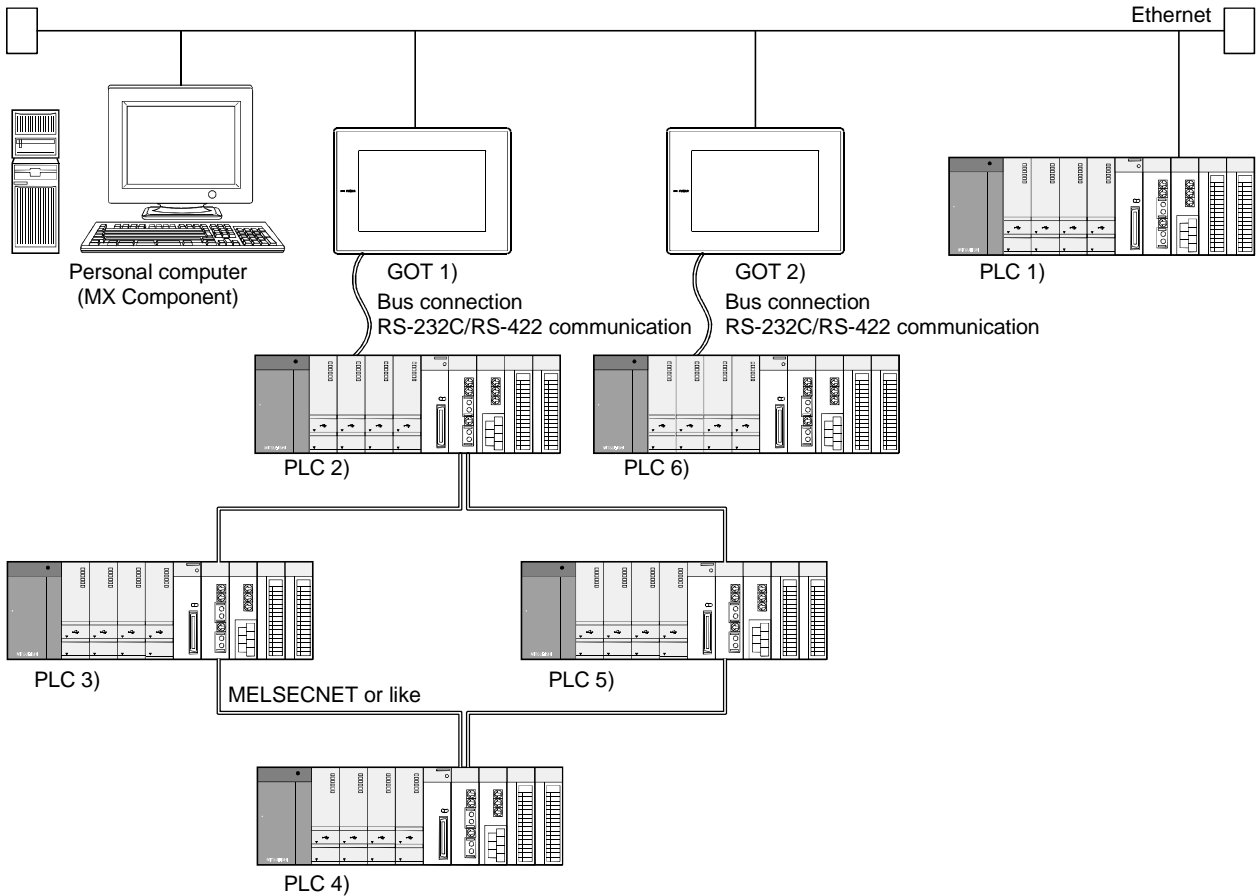

Monitor Destination \ Monitor Source	Personal computer	GOT 1) (Server)	GOT 2) (Server)	PLC 1)	PLC 2)	PLC 3)	PLC 4)	PLC 5)	PLC 6)
Personal computer	○	○	○	○	1)	1)	1)	1)	2)
GOT 1) (client)	×	○	○	×	○	○	○	○	2)
GOT 2) (client)	×	○	○	×	1)	1)	1)	1)	○

◎ : Can monitor the gateway device

○ : Can monitor the PLC CPU device.

1) : Can monitor the PLC CPU device assigned to the gateway device of the GOT 1).

2) : Can monitor the PLC CPU device assigned to the gateway device of the GOT 2).

× : Cannot monitor.

5.3 Setting Method

1 Server setting

When using the server function, you have to choose [Common] - [Gateway] - [Server] on GT Designer and make the following setting.

In the server setting, set the gateway device to be used by the GOT of the server function and the PLC CPU device to be assigned to that gateway device.

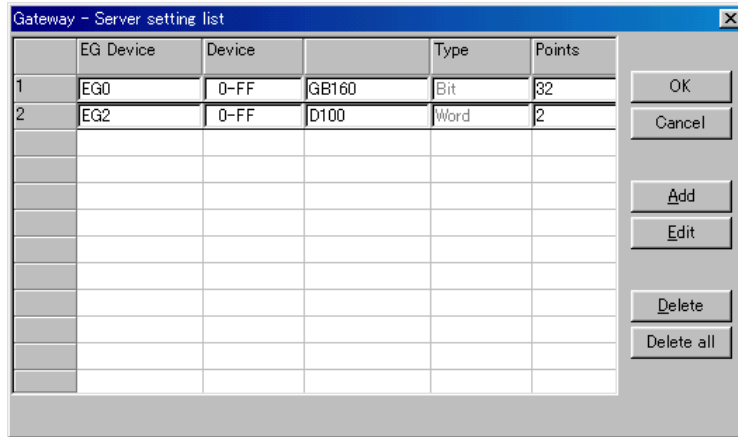

Item	Description
OK	Used to confirm the settings and close the dialog box.
Cancel	Used to cancel the settings and close the dialog box.
Add	Used to add new assignment settings. Click this switch to display the EG Device setting dialog box, and make settings. (Refer to the following (1).)
Edit	Used to change the settings made. After selecting the settings, click this switch to display the EG Device setting dialog box, and make settings. (Refer to the following (1).)
Delete	After selecting the setting, click this switch to delete the setting.
Delete all	Used to delete all settings.

(1) EG Device setting dialog box

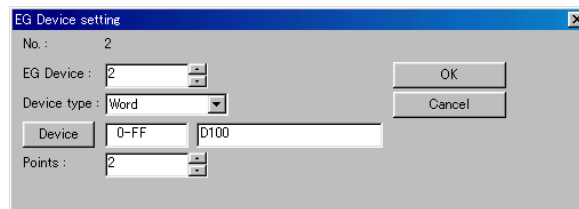

Item	Description
EG Device	Set the gateway device to which the PLC CPU device will be assigned.
Device type	Select the type of the device to be assigned.
Device	Set the N/W number, PLC station number, CPU number and device of the PLC CPU to be assigned to the gateway device. Refer to the following for the device setting method.  Help of GT Designer
Points	Register the consecutive device points in [Points] for the device type already set.

(2) Precautions for device assignment

A gateway device is set on a two point basis.

Hence, the number of assigned points changes depending on the set device type.

(a) Assignment of bit device (1-bit device)

It is assigned on a 32 point basis.

(Example) When M0 is assigned to EG0

EG0	M15 to M0
EG1	M32 to M16

(b) Assignment of word device (16-bit device)

It is assigned on a 2 point basis.

(Example) When D0 (16 bits) is assigned to EG0

EG0	D0
EG1	D1

(c) Assignment of word device (32-bit device)

It is assigned on a 1 point basis.

(Example) When CN200 (32 bits) is assigned to EG0

EG0	CN200 (lower bits)
EG1	CN200 (upper bits)

(d) Assignment of 8-bit device

It is assigned on a 4 point basis.

(Example) When E0000 is assigned to EG0

EG0	E0001	E0000
EG1	E0003	E0002

2 Client setting

When using the client function, you have to choose [Common] - [Gateway] - [Client] on GT Designer and make the following setting.

In the client setting, register the N/W No., PLC No. and IP address of the GOT of the server function to be monitored by the GOT of the client function.

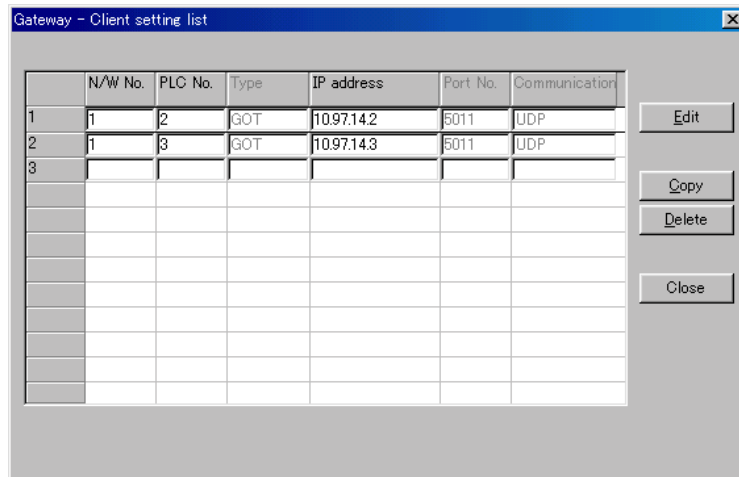

Item	Description
Edit	Click this switch to display the network setting dialog box, and make settings. (Refer to the following (1).)
Copy	After selecting the settings, click this switch to copy the settings.
Delete	After selecting the settings, click this switch to delete the settings.
Close	Used to close the dialog box.

(1) Network setting dialog box

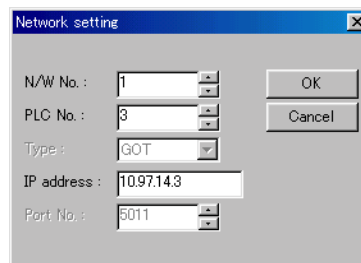

Item	Description
N/W No.	Register the network No. of the corresponding GOT.
PLC No.	Register the PLC No. (station number) of the corresponding GOT.
IP address	Register the IP address of the corresponding GOT.

5.4 Examples of Use

The following gives the examples of using the sever and client functions.

1 Making access to the PLC from the personal computer via the GOT

The device values of EG0 to EG5 of the GOT 1) (server function) are displayed on MX Component.

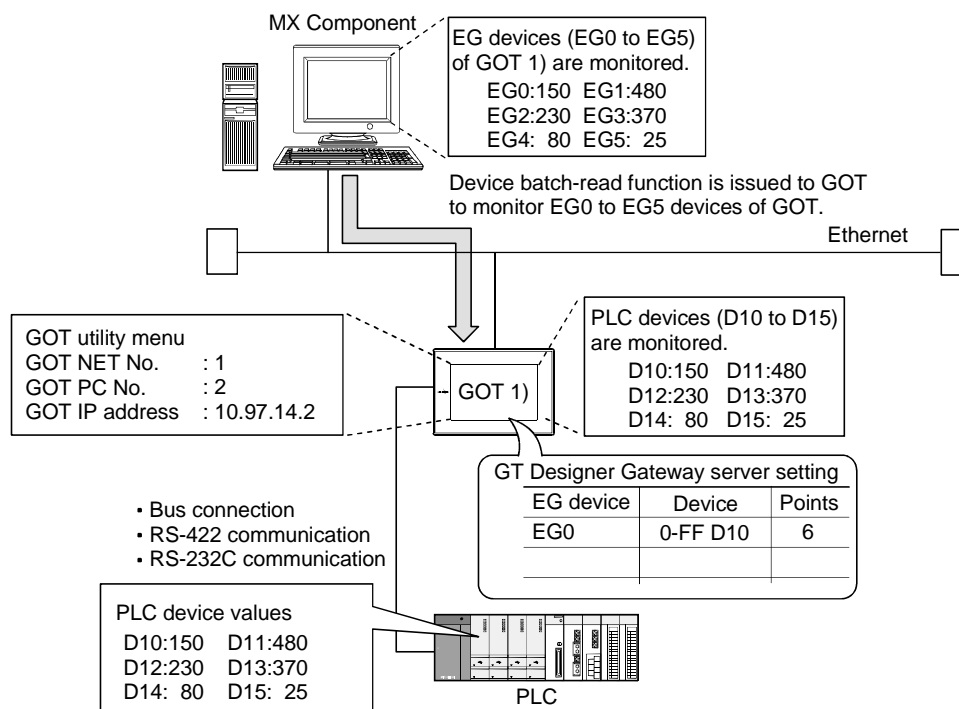

(1) GOT 1) setting example

(a) Server setting

EG Device	Device	Type	Points
EG	0-FF D10	Word	6
—	—	—	—
—	—	—	—

(b) Numerical display function

Item	Description
Device	D10 to D15
Network	Host

(2) Personal computer setting

Set the personal computer in the environment where Ethernet can be used.

2 Displaying on the client GOT the alarms that occurred on multiple PLCs

The device values of the PLC 2) and PLC 3) are transferred to the internal devices (GD100 to GD147) of the GOT 1)

The GOT 1) monitors its own internal devices, and if an alarm occurs on the PLC 2) or PLC 3), displays the occurrence information.

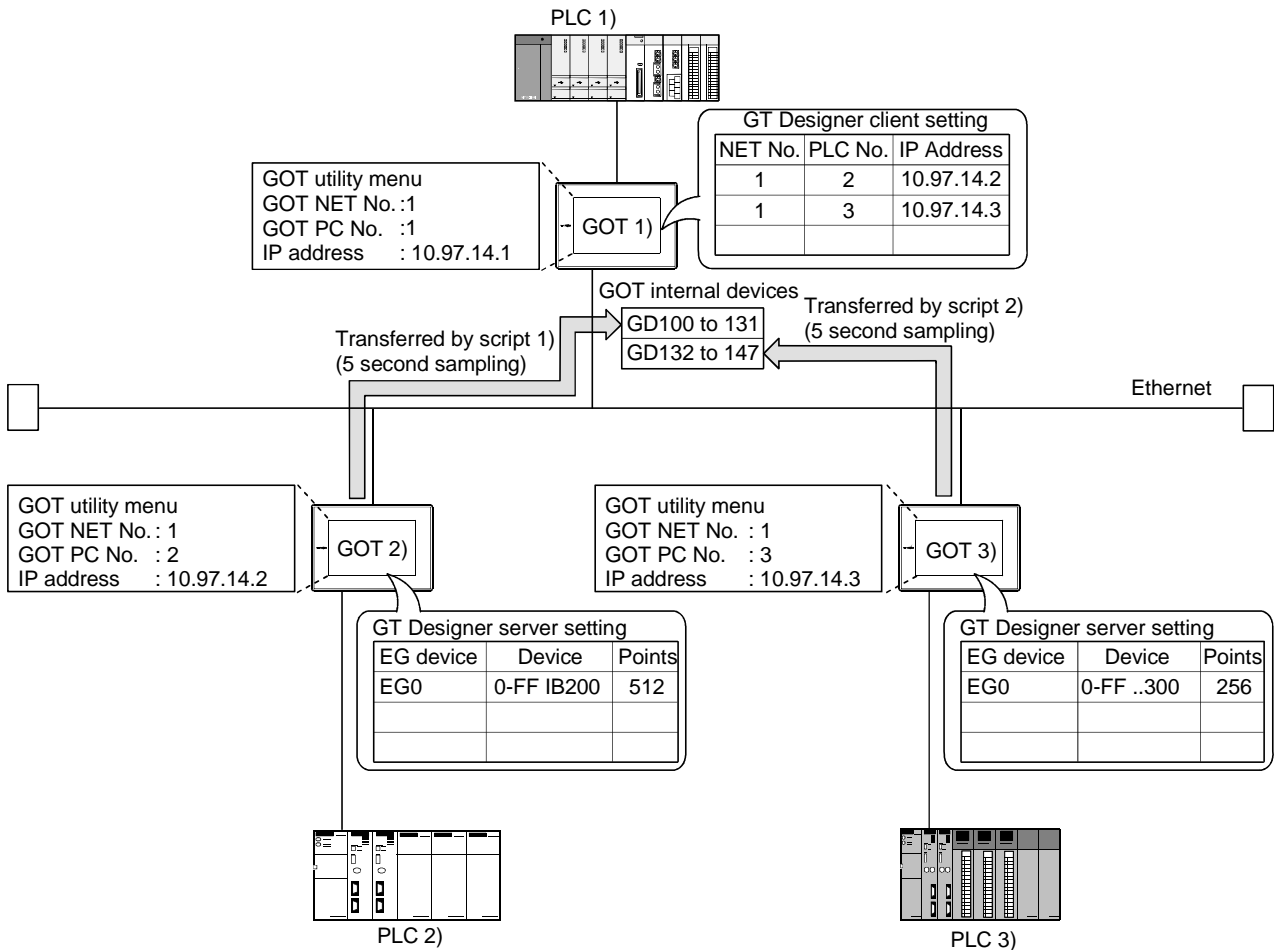

(1) GOT 1) setting example

(a) Client setting

NET No	PLC No	IP Address
1	2	10.97.14.2
1	3	10.97.14.3

(b) Alarm list display function (for GOT 2) alarm display)

Item	Description
Number of device points	512 points (consecutive)
Device	GD100.b0

(c) Alarm list display function (for GOT 3) alarm display)

Item	Description
Number of device points	256 points (consecutive)
Device	GD132.b0

* Preset the comments that will be displayed by the alarm list display functions.

(d) Script function (for GOT 2) alarm display

Item		Description
Script 1)	Type	Screen script
	Trigger type	Sampling, 5 sec
	Data format	Unsigned BIN 16-bit
	Script description	bmov([1-2:w:EG0],[w:GD100],32); //Transfers the data of 32 points, starting from EG0, of GOT 2) to GD100 and later of GOT 1).

(e) Script function (for GOT 3) alarm display

Item		Description
Script 2)	Type	Screen script
	Trigger type	Sampling, 5 sec
	Data format	Unsigned BIN 16-bit
	Script description	bmov([1-3:w:EG0],[w:GD132],16); //Transfers the data of 16 points, starting from EG0, of GOT 3) to GD132 and later of GOT 1).

(2) GOT 2) setting example

(a) Server setting

EG Device	Device	Type	Points
EG0	0-FF IB200	Bit	512
—	—	—	—
—	—	—	—

(3) GOT 3) setting example

(a) Server setting

EG Device	Device	Type	Points
EG0	0-FF ..300	Bit	256
—	—	—	—
—	—	—	—



About the trigger type

When using the script function, do not set the trigger type as [Ordinary] or [Sampling, within 2 seconds].

Doing so may affect the other monitor operations.

3 Monitoring and controlling the production conditions of multiple PLCs with the server GOT

The device values of the PLC 2) and PLC 3) are transferred to the EG devices of the GOT 1) (devices of the PLC 1)).

When values are written to the PLC 1), the EG devices of the GOT 1) (internal devices (GB100, GB101) of the GOT 1)) turn ON. (Check completion of write using the lamp display function or like.)

The GOT 1) monitors the devices of the PLC 1) to check the production conditions of the PLC 2) and PLC 3).

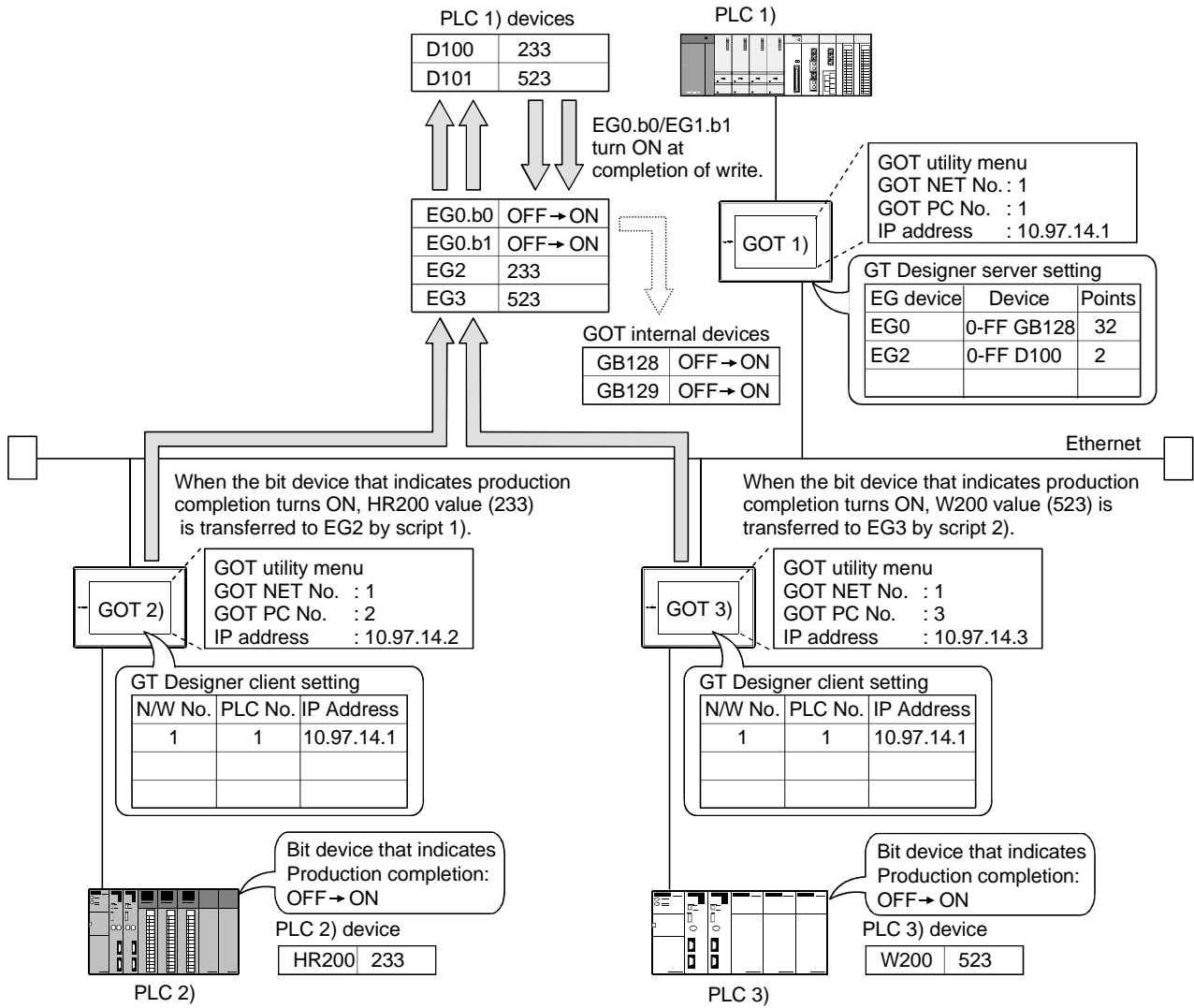

(1) GOT 1) setting example

(a) Server setting

EG Device	Device	Type	Points
EG0	0-FF GB128	Bit	32
EG2	0-FF D100	Word	2
—	—	—	—

(b) Numerical display function

Item	Description
Device	D100 to D101
Network	Host

(c) Lamp display function (set two)

Item	Description
Device	GB100 to GB101
Network	Host

(2) GOT 2) setting example

(a) Client setting

NET No	PLC No	IP Address
1	1	10.97.14.1

(b) Script function

Item	Description	
Script 1)	Type	Screen script
	Trigger type	While ON, bit device that indicates production completion
	Data format	Unsigned BIN 16-bit
	Script description	[1-1:w:EG2]=[w:HR200]; //Writes the production count to the PLC 1). set ([1-1:b:EG0.00]); //Turns ON the write completion signal.

(3) GOT 3) setting example

(a) Client setting

NET No	PLC No	IP Address
1	1	10.97.14.1

(b) Script function

Item	Description	
Script 2)	Type	Screen script
	Trigger type	While ON, bit device that indicates production completion
	Data format	Unsigned BIN 16-bit
	Script description	[1-1:w:EG3]=[w:W200]; //Writes the production count to the PLC 1. set ([1-1:b:EG0.01]); //Turns ON the write completion signal.

5.5 Precautions

This section provides the precautions for using the server and client functions.

1 Precautions for assigning the devices in the gateway setting

- (1) The gateway devices are set as at least two points, and set on a two point basis thereafter.
- (2) When a bit device is assigned, 32 points are set, starting from the set device.
- (3) When a device was not assigned, the unassigned area (empty area) is on a word basis.
- (4) The network number and PLC station number must be set to assign the MELSEC-A/QnA/Q series PLC CPU devices.
- (5) The CPU number must be set to assign the CPU of the multiple PLC system.

2 Precautions for setting the script function

- (1) When setting the script function, do not set the trigger type to [Ordinary] or [Sampling, within 2 seconds].
Doing so may affect the other monitor operations.
- (2) The script function cannot be used to monitor the gateway devices of the GOT itself.
When monitoring the PLC devices assigned to the gateway devices, monitor the PLC devices directly.

3 Precautions for using GT Simulator for debugging

- (1) GT Simulator cannot debug the gateway functions.
An error will occur if the gateway device is monitored or data is written to the gateway device.

4 Precautions for monitoring

- (1) If the GOT monitors devices by transient communication via the network, the monitor speed will decrease.
To increase the monitor speed, use link devices.
- (2) If the gateway device of the GOT of the server function is monitored in a status where the server and client functions cannot be used*, an error occurs and the script stops.
* While power is off, when the ROM_BIOS version of the GOT is incompatible, or when the memory board is not fitted, for example.
- (3) The gateway device, to which the PLC device has not been assigned, is monitored as 0 (OFF for bit).
When write is executed, the written value is invalid.
- (4) If the screen save of the GOT is canceled (by a screen touch or the human sensor) during execution of the script that uses the gateway devices, it may take some time to cancel.
When the execution of automatic screen save has been specified, it may take more time than the specified.
(For example, when the script processing time is 2 seconds, the screen save is canceled in a maximum of 2 seconds after the screen is touched.)

5.6 For Efficient Use

This section explains the points for efficient use of the server and client functions.

1 Script function setting

When the gateway devices are used directly to execute a program, the number of times to access the other GOT increases, slowing the processing.

By performing batch read from the GOT internal devices and performing batch write after execution of the processing as shown in the following (1), the number of access times can be decreased, improving the processing speed.

- (1) When performing batch read from GOT internal devices (GD) and performing batch write after processing

Access to the other station GOT occurs twice (1), (3)).

When one time of access requires 50ms, the necessary processing time is about 100ms.

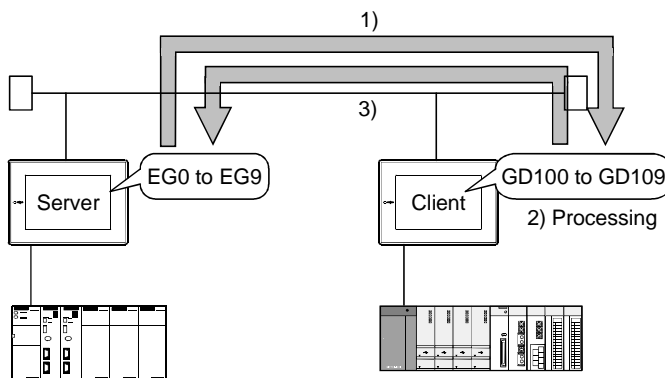

Script description example

1)	bmov([1-2:w:EG0], [w:GD100],10);
2)	[w:D200]=[w:GD100]; [w:D201]=[w:GD101]; [w:D202]=[w:GD102]; [w:D203]=[w:GD103]; [w:D204]=[w:GD104]; [w:GD105]=128; [w:GD106]=[w:D106]; [w:D205]=[w:GD107]; [w:D206]=[w:GD108]; [w:GD109]=5433;
3)	bmov([w:GD100], [1-2:w:EG0],10);

- (2) When using gateway devices directly

Access to the other station GOT occurs 10 times (1) to (10)).

When one time of access requires 50ms, the necessary processing time is about 500ms.

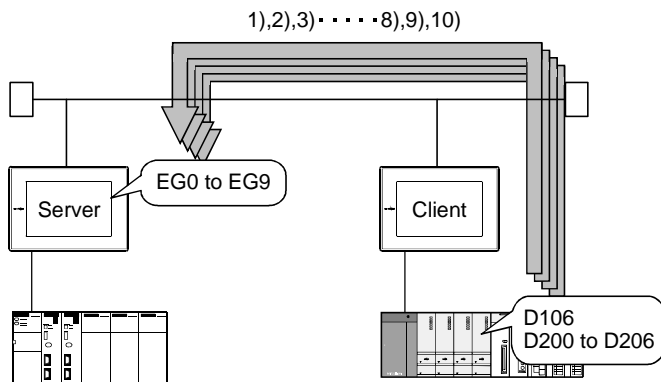

Script description example

1)	[w:D200]=[1-2:w:EG0];
2)	[w:D201]=[1-2:w:EG1];
3)	[w:D202]=[1-2:w:EG2];
4)	[w:D203]=[1-2:w:EG3];
5)	[w:D204]=[1-2:w:EG4];
6)	[1-2:w:EG5]=128;
7)	[1-2:w:EG6]=[w:D106];
8)	[w:D205]=[1-2:w:EG7];
9)	[w:D206]=[1-2:w:EG8];
10)	[1-2:w:EG9]=5433;

Point

About the written values

In the above (1), the gateway devices are batch-accessed when the script execution condition is established. Therefore, the gateway device values available when the condition is established can be processed as the written values.

In the above (2), the gateway devices are accessed one by one after the script execution condition is established. Therefore, the written values may differ from the gateway device values available when the condition is established.

2 Gateway device setting

When assigning the PLC devices to the gateway devices, set the same type of devices of the same PLC together where possible.

By setting the same devices of the same PLC together as in the following (1), the number of access times can be reduced, improving the processing speed.

(1) Devices of host, other station and other PLC are set together

When the GOT of the client function accesses the host devices of the GOT of the server function, access can be made with the program that reads 50 points starting from EG0 (1)).

	EG Device	Device		Type	Points	
1	EG0	0-FF	D100	Word	40	<input type="button" value="OK"/> <input type="button" value="Cancel"/> <input type="button" value="Add"/> <input type="button" value="Edit"/>
2	EG40	0-FF	D500	Word	10	
3	EG50	0-FF/3	D300	Word	40	
4	EG90	1-2	D200	Word	20	
5	EG110	1-2	D600	Word	60	
6	EG170	2-1	D400	Word	30	

Script description example

1) `bmov([W:GD100], [1-2:w:EG0],50);`

(2) Devices of host, other station and other PLC are set not together

When the GOT of the client function accesses the host devices of the GOT of the server function, access requires the program that reads 40 points starting from EG0 (1)) and the program that reads 10 points starting from EG130 (2)).

	EG Device	Device		Type	Points	
1	EG0	0-FF	D100	Word	40	<input type="button" value="OK"/> <input type="button" value="Cancel"/> <input type="button" value="Add"/> <input type="button" value="Edit"/>
2	EG40	1-2	D200	Word	20	
3	EG60	0-FF/3	D300	Word	40	
4	EG100	2-1	D400	Word	30	
5	EG130	0-FF	D500	Word	10	
6	EG140	1-2	D600	Word	60	

Script description example

1) `bmov([W:GD100], [1-2:w:EG0], 40);`

2) `bmov([w:GD140], [1-2:w:EG130], 10);`



Hint!

To further increase efficiency

By reserving together in advance the PLC devices to be used for the server and client functions in the system design stage as shown in the following (a), the number of times for the GOT of the server function to access the PLC can be decreased, improving the processing speed.

(a) When PLC devices are assigned together

	EG Device	Device		Type	Points	
1	EG0	0-FF	D200	Word	100	<input type="button" value="OK"/> <input type="button" value="Cancel"/> <input type="button" value="Add"/> <input type="button" value="Edit"/>

When 100 points of devices are accessed, access to the PLC occurs only once.

(b) When PLC devices are not assigned together

	EG Device	Device		Type	Points	
1	EG0	0-FF	D100	Word	30	<input type="button" value="OK"/> <input type="button" value="Cancel"/> <input type="button" value="Add"/> <input type="button" value="Edit"/>
2	EG30	0-FF	D250	Word	20	
3	EG50	0-FF	D20	Word	10	
4	EG60	0-FF	D360	Word	20	
5	EG80	0-FF	D400	Word	20	

When 100 points of devices are accessed, access to the PLC must be made five times.

3 Performance of server and client functions (reference values)

The following table indicates the performance of the server and client functions (reference values) when **1** and **2** on the previous pages are used.

The reference values of the performance assume the following conditions.

- System consists of one GOT of server function and one GOT of client function
- GOT of server function : Numerical input setting of 64 points
- GOT of client function : Numerical input setting of 64 points
- Number of assigned device points : Word devices of 10 points

Item	bmov is used (Batch access)	Device are assigned together	Response speed for bus connection	Response speed for CPU direct connection
1	○	○	Approx. 140ms	Approx. 260ms
2	○	×	Approx. 700ms	Approx. 1300ms
3	×	○	Approx. 700ms	Approx. 1300ms
4	×	×	Approx. 700ms	Approx. 1300ms

When there are multiple clients, the response speed is the "above response speed×number of clients".

(When there are five clients in above "1", the response speed for bus connection is approximately 700ms.)

6. FTP SERVER FUNCTION

This chapter describes the FTP server function.

6.1 Specifications

6.1.1 Specifications

The specifications of the FTP server function are indicated below.

Item	Specifications	Setting Method
FTP server function setting	Whether the function will be used or not can be set (default: Not used)	GT Designer
User name	1 to 12 alphanumeric characters (case sensitivity, anonymous must not be used) (default: GOT900)	GT Designer
Password	1 to 8 alphanumeric characters (case sensitivity) (default: GOT900)	GT Designer
Port number	20, 21	Fixed
Number of clients that can connect simultaneously	1 unit	Fixed
Time set to watching timer of command input	Before login * 1	1 minute
	After login * 2	1 to 60 minutes (default: 15 minutes)
File size that can be read	Unlimited (max. read size depends on PC card capacity.)	—
File name	Within 8 characters of only alphanumeric characters (longer file name not acceptable)	—
Access mode	Normal: Reference mode (write to PC card disabled) Write is enabled after issue of dedicated command	—
FTP client	<ul style="list-style-type: none"> • General-purpose FTP client tool can be used. * 3 • Access can be made by FTP command from Windows® MS-DOS prompt or command prompt. 	—
Memory space used by GOT (bytes)	12 + 2 × total number of login name and password characters	GT Designer

* 1 The line is cut off if a correct password and login name are not entered within 1 minute after line connection with the GOT.

* 2 The GOT cuts off the line if a command is not input from the FTP client within the time set to the watching timer of command input.

* 3 Microsoft® Internet Explorer and Netscape Communicator are unusable.

The following table indicates the FTP client tools that have been confirmed to operate properly by Mitsubishi Electric.

Name	Compatible OS
FFFTP (freeware)	Microsoft® Windows® 98 operating system, Microsoft® Windows® Millennium Edition operating system,
NextFTP Ver. 2 (shareware)	Microsoft® WindowsNT® Workstation4.0 operating system, Microsoft® Windows® 2000 Professional operating system

6.1.2 File accessible range

The FTP server function can access on the PC card of the GOT within the network to which the FTP client is connected. (Multiple clients cannot access the PC card of the GOT simultaneously.)
When using a relay device such as a router, consult the network manager.

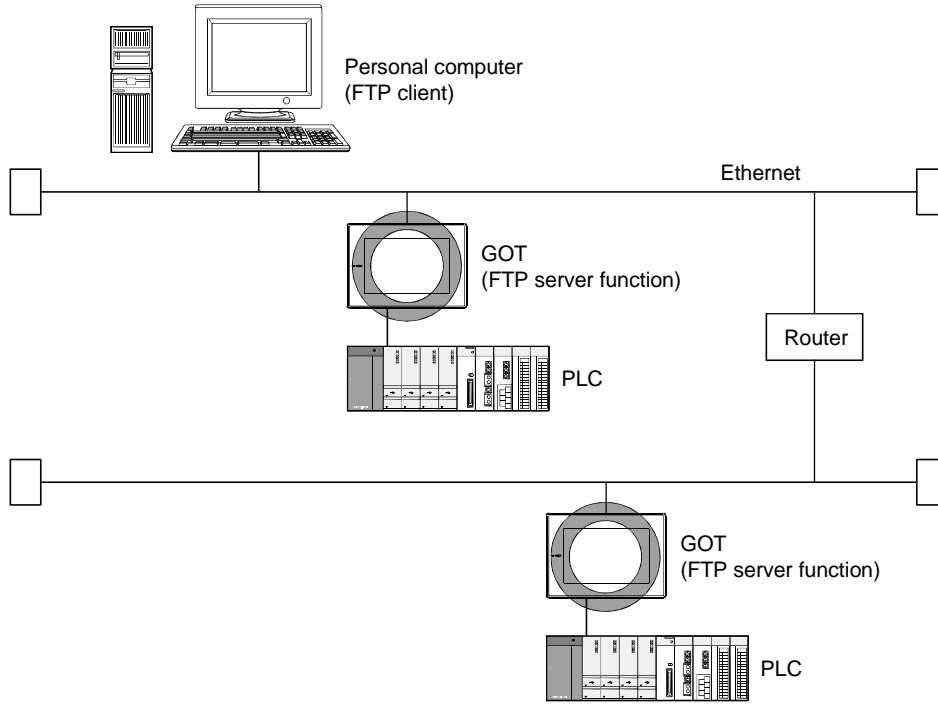

Hint!

Simple judgment of whether file access is possible or not

Simple judgment of whether file access is possible or not can be made by issuing the ping command to the GOT.

Example of issuing the ping command (Windows® MS-DOS prompt)
IP address of GOT: 10.97.14.10

• When file can be read

```
C:\ping 10.97.14.10
pinging 10.97.14.10 with 32 byte of data:
reply from 10.97.14.10: bytes=32 time<10ms ttl=128
reply from 10.97.14.10: bytes=32 time<10ms ttl=128
reply from 10.97.14.10: bytes=32 time<10ms ttl=128
C:\
```

• When file cannot be read

```
C:\ping 10.97.14.10
pinging 10.97.14.10 with 32 byte of data:
request timed out.
request timed out.
request timed out.
C:\
```

6.2 Setting Method

When using the FTP server function, you have to choose [Common] - [Gateway] - [FTP Server] on GT Designer and make the following setting.

The setting method of the FTP server function is given below.

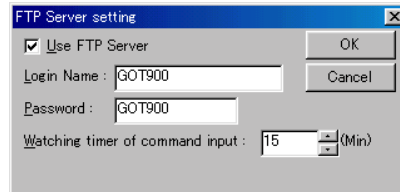

Item	Description
Use FTP Server	Check here when using the FTP server function.
Login Name	Set the login name used when the FTP client connects to the GOT. You can set only one login name up to 12 characters. Only alphanumeric characters (a to z, A to Z, 0 to 9) can be used.
Password	Set the password used when the FTP client connects to the GOT. You can set only one password up to 8 characters. Only alphanumeric characters (a to z, A to Z, 0 to 9) can be used.
Watching timer of command input	Set when the line with the GOT will be cut off if no command is entered from the FTP client. You can set this time between 1 and 60 minutes in 1 minute increments. Normally use it as default (15 minutes).

6.3 Operation on the FTP Client Side

6.3.1 Input command at FTP client

1 General commands

The following table indicates the correspondences between the commands that can be used with a general FTP client tool and the FTP server function of the GOT.

The usable commands change depending on the FTP client tool used.

For details, refer to the manual of the used FTP client tool.

○: Usable ×: Unusable △: Setting invalid (command does not result in error)

Command Name	Function	Reference Mode	Write Mode
append	Additionally writes a file to the GOT (PC card).	×	○
ascii	Changes the file transfer mode to the ascii mode.	△ * 1	△ * 1
binary	Changes the file transfer mode to the binary mode.	○	○
bye	Exits the FTP client tool.	○	○
cd	Changes the current directory of the GOT (PC card).	○	○
close	Cuts off the line with the GOT.	○	○
delete	Deletes a file in the GOT (PC card).	×	○
dir	Reads the file information in the GOT (PC card).	○	○
get	Reads a file from the GOT (PC card).	○	○
ls	Displays file names in the GOT (PC card).	○	○
mdelete	Deletes multiple files specified using a wild card.	×	○
mdir	Reads the file information in the GOT (PC card) to the specified file.	○	○
mget	Reads multiple files.	○	○
mkdir	Creates a directory in the GOT (PC card).	×	○
mls	Reads the file names in the GOT (PC card) to the specified file.	○	○
mput	Writes the specified multiple files using a wild card to the GOT.	×	○
open	Connects the line with the GOT.	○	○
put	Write a file to the GOT (PC card).	×	○
pwd	Creates the current directory of the GOT.	○	○
quit	Cuts off the line with the GOT to exit the FTP client tool.	○	○
quote	Used when the GOT-dedicated command is used. (Example: quote gtwr)	○	○
user	Enters the user name and password used to log in to the GOT.	○	○

* 1 Since this command is fixed to "No file conversion (binary)" in the FTP server function, it is invalid if set.

* 2 The rename and rmdir commands are unusable.

2 GOT-dedicated commands

When the line with the GOT is connected, the FTP client is in the "reference mode" in which only file read is enabled.

Before executing file write, delete or directory creation, change it to the "write mode".

To select the reference mode or write mode, issue a mode change command.

○: Usable △: Setting invalid (command does not result in error)

Command Name	Function	Reference Mode	Write Mode
quote gtwr	Changes the FTP server function mode of the GOT to the write mode.	○	△
quote gtrd	Changes the FTP server function mode of the GOT to the reference mode.	△	○
quote help	Displays the general-purpose actual commands of the FTP protocol supported by the FTP server function of the GOT.	○	○

6.3.2 File specifying method

There are two file specifying methods: one is to specify one file directly and the other is to specify multiple files that meet the condition.

1 Specifying the file name to read

Specify the file name, period and extension of the file to be specified.

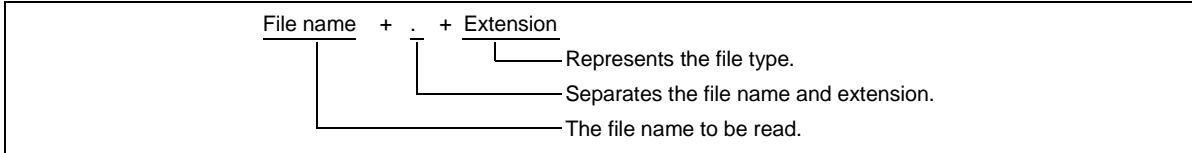

The FTP server function mainly uses files having the following extensions.

Extension	Application on GOT
csv	Recipe file (recipe function), alarm history file (alarm history display function)
bmp	Monitor screen image (hardcopy function)
jpg	

2 Specifying the files that meet the condition (wild card)

When specifying multiple files, you can use "*" or "?" as a wild card.

(Example)

- When specifying only JPEG files *.jpg
- When specifying the CSV files that begin with Main..... Main*.csv
- When specifying the files whose extensions begin with b *.b??



(1) Precautions for specifying the file name

For the FTP server function, do not put a space into a file name or extension. The file that has a space cannot be read or written as a correct file name.

(2) About data in PC card

The PC card of the GOT contains the files that can cause the operation fault of the GOT if they are deleted.

To prevent the operation fault of the GOT, do not access the folders, which store the above files, from the FTP client.

<Folder structure in the PC card>

Can be used with the FTP server function.	{ <ul style="list-style-type: none"> ALARMHST..... For alarm history file storage RECIPE For recipe file storage REPORT For report file storage SNAPSHOT..... For screen image file storage SNAPHDCP.BMP... Work file for printer printout 					
		Cannot be used with the FTP server function.	{ <ul style="list-style-type: none"> USERDATA..... For monitor screen data storage (for screen copy) OS For OS storage (for OS copy) SYSTEMD..... For OS system screen storage (for OS copy) SPCDATA For special function module monitor data storage (for screen copy) 			
				Do not delete files.	{ <ul style="list-style-type: none"> For motion monitor data storage (for screen copy) For servo amplifier monitor data storage (for screen copy) 	
						{ <ul style="list-style-type: none"> For motion monitor data storage (for screen copy) For servo amplifier monitor data storage (for screen copy)

* In addition to the above, do not delete the file whose extension is "ini" (GOT information file).

6.3.3 Checking the line connection condition

The connection condition of the line between the GOT and FTP client is stored into the GOT special register GS200.b2 (bit position: 2).

By referring to this bit on the GOT, you can check whether the line is connecting or not.

Device Name	ON	OFF
GS200.b2	Connecting	Cut off

Refer to the following manual for details of the GOT special registers.

 GT Works Version5/GT Designer Version5 Reference Manual



Example of using GS200.b2

- (1) Using the above device with the lamp display function, you can create a line condition confirmation lamp.

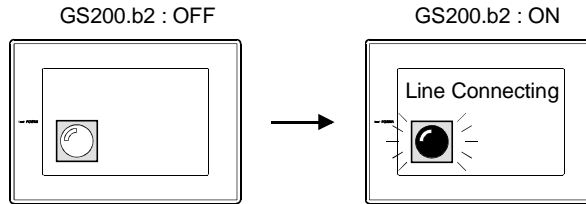

- (2) By setting the above device to the operation condition as a trigger using the touch key function or numerical input function, you can restrict operation (input) while the line is connecting.

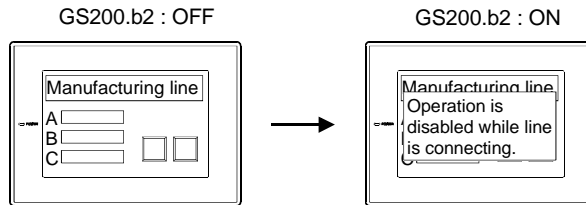

Using the touch key function or numerical input function, make setting to enable input only when the device (GS200.b2) is OFF.

6.3.4 Line cutoff

There are two line cutoff methods: automatic cutoff and manual cutoff.

1 Automatic cutoff

The GOT cuts off the line automatically if no command is entered from the FTP client within the time set to the watching timer of command input in the FTP server setting.

The watching timer of command input is always set.

Refer to the following for the setting of the watching timer of command input.

 Section 6.2 Setting Method

2 Manual cutoff (Forcibly cutting off the line)

Using the GOT special register GS400.b2 (bit position: 2), you can cut off the line forcibly.

When you want to cut off the line, turn "ON" GS400.b2 (bit position: 2).

Refer to the following manual for details of the GOT special registers.

 GT Works Version5/GT Designer Version5 Reference Manual



Precautions for use of GS400.b2

After confirming that the line has been cut off, always turn "OFF" GS400.b2.



About line cutoff

Since the GOT cannot detect the fault status of the FTP client, it does not cut off the line immediately if the FTP client could not exited properly (e.g. the personal computer was powered off while the line is connecting).

However, as the watching timer of command input has been set, the line is cut off automatically in the predetermined period of time.

6.4 Example of Use

The example of using the FTP server function is described below.

In this example of use, the Windows® MS-DOS prompt is used to access the GOT and FTP client.

When performing operation using the commercially available FTP client tool or like, refer to the manual of the FTP client tool used.

1 General procedure

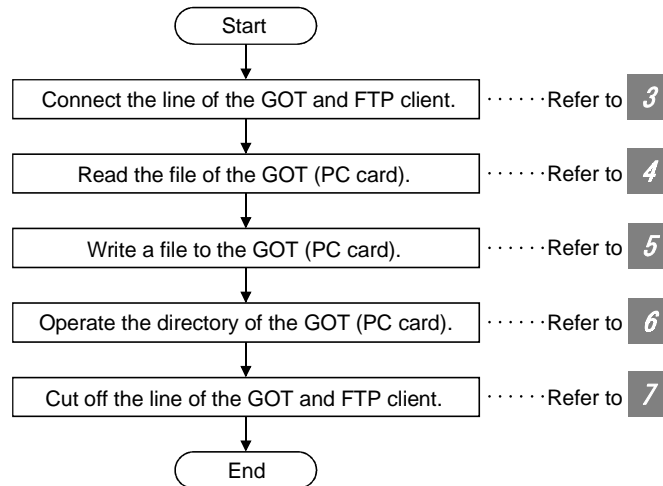

Point

Precautions for file write

When writing a file to the GOT (PC card) or operating the directory, turn ON the memory card access switch of the GOT to make the PC card write-enabled.

2 System configuration

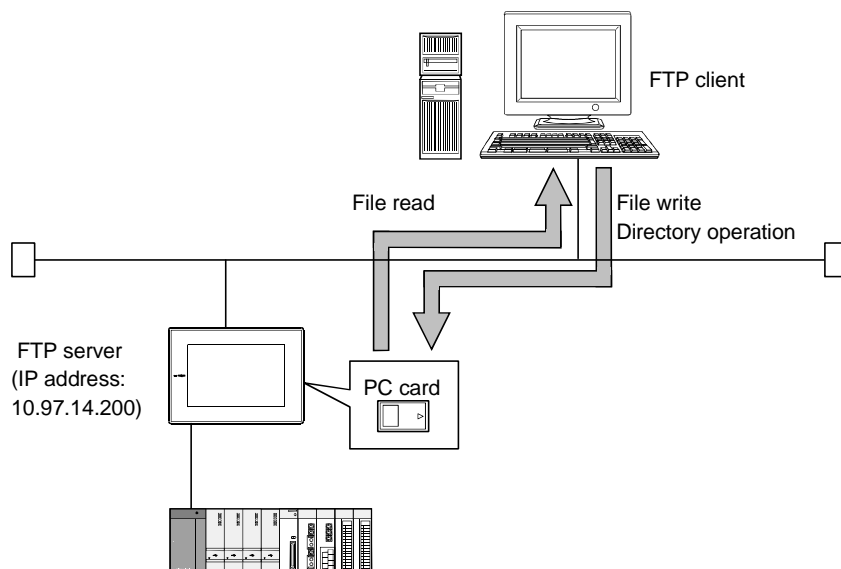

3 Connecting the line of the GOT and FTP client.

Connect the GOT and FTP client in the following procedure.

- 1 Start of the FTP client..... ftp ↵
- 2 Connection with the GOT open IP address of GOT ↵
- 3 Input of the login name..... login name ↵
- 4 Input of the password password ↵

Login image (when the line was connected properly)

```
C:\>ftp
ftp>open 10.97.14.200
connected to 10.97.14.200
220 GOT900 FTP server ready.
user:GOT900
331 Password required.
Password:****
230 User logged in.
ftp>
```

Login image (when the other personal computer has already connected to the GOT)

```
C:\>ftp
ftp>open 10.97.14.200
connected to 10.97.14.200
220 GOT900 FTP server ready.
user:GOT900
530 Not logged in.
ftp>
```

Login image (when the password is incorrect)

```
C:\>ftp
ftp>open 10.97.14.200
connected to 10.97.14.200
220 GOT900 FTP server ready.
user:GOT900
331 Password required.
Password:****
530 Not logged in.
ftp>
```

4 Reading the file of the GOT (PC card).

Read the file in the following procedure.

- 1 Notification of no file conversion binary ↵
- 2 Read of file get file name ↵

Read image

```
ftp>binary
200 Command Okey.
ftp>get SNAP0001.BMP
200 PORT command successful
150 Opening connection.
226 Closing data connection.
250 bytes received in 0.02 seconds
ftp>
```

5 Writing a file to the GOT (PC card).

Write a file in the following procedure.





- 1 Notification of no file conversion binary ↵
- 2 Selection of the write mode quote gtwr ↵
- 3 Display of the file name to check for the same file name..... ls ↵ or dir ↵
- 4 Deletion made if the same file exists..... delete file name ↵
- 5 File write put file name ↵

Write image

```
ftp>binary
200 Command Okey.
ftp>quote gtwr
200 command successful.
ftp>ls
200 PORT command successful
SNAP0001.BMP
SNAP0002.BMP
226 Closing data connection.
ftp>delete SNAP.0001.BMP
200 Command Okey.
ftp>put SNAP0001.BMP
200 PORT command successful
150 Opening connection.
226 Closing data connection.
250 bytes sent in 0.01 seconds.
ftp>
```

6 Operating the directory of the GOT (PC card).

Create and change the directory in the following procedure.

- 1 Current directory display pwd 
- 2 Selection of the write mode quote gtwr 
- 3 Directory creation mkdir directory name 
- 4 Current directory change cd directory name 

Directory operation image

```
ftp>pwd
257 "A:\snapshot" is current directory.
ftp> quote gtwr
200 command successful.
ftp>mkdir bmpdata
275 MKD command successful.
ftp>cd bmpdata
250 CWD command successful.
ftp>pwd
257 "A:\snapshot\bmpdata" is current directory
ftp>cd ..
250 CWD command successful.
ftp>pwd
257 "A:\snapshot" is current directory.
ftp>
```

7 Cutting off the line of the GOT and FTP client.

Cut off the GOT and FTP client in the following procedure.

- 1 Quit command quit 

Logout (line cutoff) image

```
ftp>quit
221 User logged out. Good-Bye.
C:\>
```

8 Error display

An error that occurred in the FTP server function is displayed on the FTP client. Refer to the following for the displayed error messages.

 Section 8.2 Error Messages

If an attempt was made to read a non-existing file snap0010.bmp

```
ftp>get snap0010.bmp
200 PORT command successful.
550 snap0010.bmp.No such file or directory.
C:\>
```

6.5 Precautions

The following are the precautions for using the FTP server function.

1 Precautions for system design using the FTP server function

- (1) When writing a recipe file from the FTP client to the GOT, set the format of the recipe file as set for the recipe function of the GOT.
When writing a recipe file from a remote location, confirm the operation with the field site personnel before executing write.
- (2) Before using the FTP client tool, refer to the manual of the FTP client tool, confirm its functions and operation methods, and make tests before starting operation.
Depending on the FTP client tool used, the GOT (FTP server) may not support some operations. Also, depending on the FTP client tool used, the FTP server function may not be usable since the GOT cannot support the extended command (quote) and issue the GOT-dedicated command.
- (3) If a number of files are read at once under one command (e.g. get or put is executed by specifying a wild card), processing may be delayed by network congestion. If processing is slow, issue commands separately to perform the processing separately.

2 Precautions for file read

- (1) The GOT cuts off the line if no command is input from the FTP client for longer than the time set to the watching timer of command input.
- (2) The line is cut off if any of the GOT IP address, router address and subnet mask is changed while the line of the GOT and FTP client is connecting.
- (3) The line is kept connected if the GOT is put offline (e.g. the monitor screen data is downloaded) while the line of the GOT and FTP client is connecting.
- (4) When you want to change (rewrite) the contents of the recipe file, make the recipe inactive.
If the recipe file in the PC card is deleted during recipe processing, the function will not operate properly.
If the recipe file is deleted other than during recipe processing, an error (system alarm: recipe file error) will occur in the next recipe operation.
( Section 6.3.3 Checking the line connection condition)
- (5) Do not delete the printer printout temporary file.
If the printer printout temporary file is deleted, the function will not operate properly.
- (6) If the FTP client has become faulty (personal computer), wait until the time set to the watching timer of command input elapses or turn ON the forced logout signal "GS400.b2" to cut off the line, and log in again.
The line connecting condition can be checked using GS200.b2 (bit position: 2).
- (7) Do not power off the GOT while access is being made from the FTP client to the file in the PC card of the GOT.
Doing so may damage the data in the PC card.

- (8) If you reset the GOT or switch power off while the line of the GOT and FTP client is connecting, the operation of the FTP client depends on the specifications of the FTP client tool used. Use the FTP client tool that supports the detection of an FTP server fault or that can be exited properly.
- (9) Access to a file cannot be made if the memory card access switch of the GOT is OFF.
- (10) Write processing (put) cannot be performed if the write protect switch of the GOT is ON.
- (11) The GOT does not use any file whose file name is 8 or more characters long. Hence, if the PC card contains a file whose file name is 9 or more characters long, it cannot be accessed from the FTP client. Set the file name of a file to be accessed to within 8 characters (except a period and extension).
- (12) Depending on the used FTP client tool, the time stamp may differ from that of the file in the PC card of the GOT. If the time stamp differs, check the setting of the FTP client tool.

3 Precautions for FTP login

- (1) If you have forgotten the password for FTP login, connection to the GOT cannot be made. You can confirm the set password on GT Designer.
- (2) You cannot log in to the GOT from multiple FTP clients simultaneously.

7. MAIL SEND FUNCTION

This chapter describes the mail send function.



(1) About the mail software

The GOT (send source) does not require mail software.

(2) About the system when using the mail send function

The SMTP (mail) server must be installed in the intranet to use the mail send function.

7.1 Specifications

7.1.1 Specifications

The specifications of the mail send function are given below.

Item	Specifications	Setting Method
SMTP server	IP address setting (1 server only)	Fixed
	Port	25
	Server certification	Disabled
Send destination address	To	GT Designer
	Cc	
	Bcc	
Subject	Max. 128 characters (alphanumeric characters only)	GT Designer
Text data size	Either of the following two different comments can be sent. Alarm comment: Max. 512 characters (alphanumeric characters) Detailed comment: Max. 512 characters (alphanumeric characters)	—
Attached file	Disabled	—
Encoding	No	—
Compression	No	—
Memory space used by GOT (bytes)	$20 + 4 \times (\text{number of destinations} + 2) + 2 \times (\text{total number of destination, subject and sender characters})$	GT Designer

The following table indicates the mail software programs that have been confirmed to operate properly by Mitsubishi Electric.

Name	Maker	Compatible OS
OutlookExpress5	Microsoft	Microsoft® Windows® 95 operating system, Microsoft® Windows® 98 operating system,
Netscape Communicator 4.7 or later	Netscape	
AL-Mail32 Version1.12 (shareware)	—	Microsoft® Windows® Millennium Edition operating system, Microsoft® WindowsNT® Workstation4.0 operating system,
Winbiff	Orange Software	Microsoft® Windows® 2000 Professional operating system

7.1.2 Mail send enabled range

Since the IP address is used to specify the SMTP server in the mail send function of the GOT, a dial-up router cannot be utilized to send mail. (The SMTP server in the Internet service provider cannot be used.) Install the SMTP (mail) sever in the intranet.

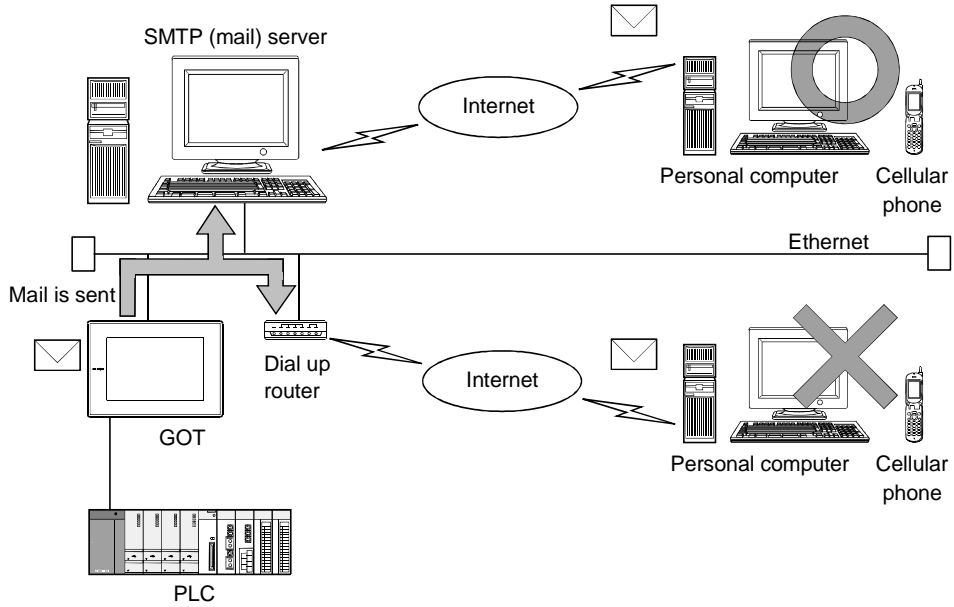

7.2 Setting Method

When using the mail send function, you have to choose [Common] - [Gateway] - [Mail] on GT Designer and make the following setting.

Only one mail send setting can be made for one GOT.

Item	Description
Available E-Mail	Check here when using the mail send function.
SMTP Server	Set the IP address of the SMTP server used.
FROM * 1	Enter the address of the mail send source. (Alphanumeric characters only)
SUBJECT * 2	Enter the title of the mail. (Alphanumeric characters only)
TO * 3	Enter the address of the mail send destination. (Alphanumeric characters only)
CC	Enter the address of the mail send destination (copy). (Alphanumeric characters only, mail can be sent if this address is not entered.)
BCC	Enter the address of the mail send destination (hidden copy). (Alphanumeric characters only, mail can be sent if this address is not entered.)

* 1 Since the GOT does not have the mail receive function, set the reply destination in "FROM" when the mail receiver from the GOT will make a reply.

When there is no specific reply destination, set the address as set in "TO".

* 2 When mail is to be received from multiple GOTs, the GOTs that have sent mail can be identified if you enter different subjects into the GOTs.

* 3 When setting multiple send destination addresses, separate them with a space or comma.

7.3 Send Examples

When e-mail is sent from GOT to the target device, the reception header part shown at the destination displays a message that shows that the e-mail is from GOT.

Example of display in the reception header part at the destination

```
From:*****  
To:*****  
Cc:*****  
Subject:GOT 01  
:  
X-Mailer:GOT
```

Point

About mail send

- (1) The format and contents of the display of e-mail sent vary depending on the mailer specifications used at the destination.
- (2) When e-mail is sent to a mobile phone, the display may vary depending on the specifications (screen size) of the mobile phone.
- (3) GOT can send up to 16 e-mail at one time. If alarms occur 17 times or more, the 17th e-mail and subsequent are not sent.

1 When sending e-mail using the alarm history display function

If an alarm occurs in GOT, the time and information of the alarm are sent to the destination by e-mail. Moreover, if the alarm recovers, the time and information of the alarm recovery are sent to the destination by e-mail.

Refer to the following manual for the way to set the alarm history display function.

 Help function of GT Designer

- (1) Example of display at the destination (when an alarm occurred)

```
[Alarm history occurred information]  
[Occur Time]  
2002/11/28 09:48:15  
(a) → [Occur Information]  
Line A supply conveyor stopped.  
(b) → [detailed Information]  
Alarm history: A-line supply converter stopped.  
Check the power source.
```

- (a) The comment entered in the alarm history display function is displayed.
- (b) The content of detailed display entered in the alarm history display function is displayed. "Detail Information" is not displayed if the detail display setting of the alarm history display function has not been made or has been made for the base or window screen. ("Alarm history: detail comment nothing" appears under "Detail Information".) To display "Detail Information", make the detail display setting in the comment window.

(2) Example of display at destination (when an alarm recovered)

[Alarm history repaired information]
[repair Time]
2002/11/28 10:38:23
[repair Information]
Alarm "Line A supply conveyor stopped." recovered.
Alarmhistory:detail comment nothing

7.4 Examples of Use

1 Sending the definition of the alarm that occurred in the GOT to the production site and office by mail

If an alarm has occurred in the GOT, mail is sent to the personal computer 1) (production site (operator)), cellular phone and personal computer 2) (office (manager)).

On the production site where the alarm was received, the system is repaired/recovered.

At the office, the manager can send mail to prompt the operator on the production site to report the current restoration condition.

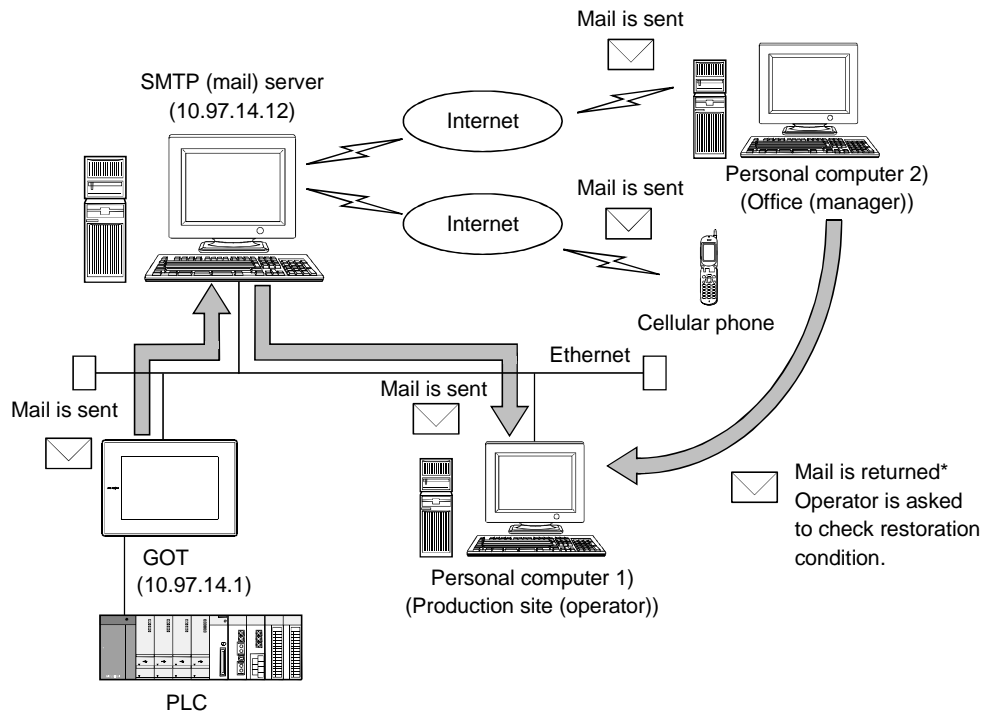

* Since the GOT cannot receive mail, set FROM as the mail address of the personal computer or like on the production site.

This allows the mail to be returned from the office (manager) to the production site and the mail requesting confirmation of the restoration condition to be sent to the production site.

(1) GOT setting example

(a) Utility menu of GOT

Item	Description
IP address	10.97.14.1
Send message wait	000 × 10ms
Send message time	03 seconds
Startup time	003 seconds

(b) Mail setting

Item	Description
SMTP (mail) server	10.97.14.12
FROM	Mail address of personal computer 1)
TO	Mail address of personal computer 1)
CC	Mail address of personal computer 2) Mail address of Cellular phone
subject	GOT01

(c) Alarm history display function (alarm history common setting)

Item	Description
Monitor device	Mail send
Send mail	Occurred/restored

* Preset the comment to be displayed for the alarm history display function.

7.5 Precautions

The precautions for using the mail send function are described below.







- (1) The languages that can be sent by mail is only English.
The other languages are sent as "?" by mail.
- (2) The GOT refers to the PLC CPU clock every 60 minutes.
Note that if the time is changed on the PLC side, an error of up to 60 minutes will be produced.
- (3) The mail send date/time is the time of the SMTP server at the time of send.

8. TROUBLESHOOTING

This chapter describes the troubleshooting of the gateway functions.

8.1 Troubleshooting Common to Gateway Functions

The following troubleshooting is common to the gateway functions.

Phenomenon	Definition and Cause	Corrective Action
The GOT displays the "Check Communication" message.	The mounting position of the serial communication board is incorrect.	Mount the serial communication board on the GOT. ( User's Manual (Details) of used GOT)
	The version of the ROM_BIOS. OS installed in the GOT is incorrect.	Match the versions of the OSs to be installed. (All versions of the basic function OS, PLC communication driver and extended function OS should be Ver. 9.*.* or later.) ( GT Works Version 5/GT Designer Version 5 Reference Manual)
The ERR. LED is lit on the PLC. * 1	The used A9GT-J71E71-T is not compatible with the gateway functions.	Use the A9GT-J71E71-T (hardware version E (June, 2002) or later) that is compatible with the gateway functions. ( Section 2.3)
The gateway functions are not executed.	The used A9GT-J71E71-T is not compatible with the gateway functions.	Use the A9GT-J71E71-T (hardware version E (June, 2002) or later) that is compatible with the gateway functions. ( Section 2.3)
	The extended function OS of the gateway functions has not been installed in the GOT.	Install the extended function OS of the gateway functions into the GOT. ( GT Works Version 5/GT Designer Version 5 Reference Manual)
	The memory board has not been mounted. (When A985GOT, A97 *GOT, A960GOT or A956WGOT is used)	Mount the memory board to the GOT.
	The memory extension type (-M3 type) GOT is not used. (When A956GOT is used)	Use the memory extension type (-M3 type) GOT.
	The IP address has not been set to the GOT.	Using the utility function of the GOT, check whether the IP address has not been set to the GOT.
	The mounting position of the bus connection board is incorrect.	Mount the bus connection board on the A9GT-J71E71-T. ( Section 2.4)
When any of the GS200 bits is ON and response is made to Ping * 2, * 3	—	Refer to the troubleshooting of the function corresponding to the ON bit and take a corrective action. ( Section 8.2)

* 1 "1401 : SP. UNIT DOWN" is displayed in the PLC diagnostics of GX Developer.

* 2 Refer to the following for details of the gateway common information (GS200).

 Section 8.2 Gateway Information

* 3 Check whether response is made to Ping or not by issuing the Ping command to the GOT from the personal computer.

Example: ping "IP address of GOT" in Command Prompt

8.2 Gateway Information

The error information of the gateway functions is stored into the GOT special registers (GS).
By monitoring the following GOT special registers, you can confirm the error information of the gateway functions.

Refer to the following manual for details of the GOT special registers.

 GT Works Version5/GT Designer Version5 Reference Manual

1 Error information list of gateway functions

(1) GOT write information

Device	Function	Description	
GS200	Gateway common information	Refer to (a) on the next page.	
GS201	Mail send function	Error counter	Stores the number of error occurrences.
GS202		Error code	Stores the error code (refer to Section 8.4.1).
GS203		Occurrence date and time	Stores the year (upper byte, 2 lower digits of year) and month (lower byte) of the error occurrence date and time in BCD code.
GS204			Stores the day (upper byte) and hour (lower byte) of the error occurrence date and time in BCD code.
GS205			Stores the minute (upper byte) and second (lower byte) of the error occurrence date and time in BCD code.
GS206 to 209		Reserved	—
GS210	Server function	Error counter	Stores the number of error occurrences.
GS211		Error code	Stores the error code (refer to Section 8.2.1).
GS212		Occurrence date and time	Stores the year (upper byte, 2 lower digits of year) and month (lower byte) of the error occurrence date and time in BCD code.
GS213			Stores the day (upper byte) and hour (lower byte) of the error occurrence date and time in BCD code.
GS214			Stores the minute (upper byte) and second (lower byte) of the error occurrence date and time in BCD code.
GS215		Request source	Stores the lower part of the IP address of the GOT (client function) where the error occurred in BIN code.
GS216			Stores the upper part of the IP address of the GOT (client function) where the error occurred in BIN code.
GS217 to GS219	Reserved	—	
GS220	Client function	Error counter	Stores the number of error occurrences.
GS221		Error code	Stores the error code (refer to Section 8.2.1).
GS222		Occurrence date and time	Stores the year (upper byte, 2 lower digits of year) and month (lower byte) of the error occurrence date and time in BCD code.
GS223			Stores the day (upper byte) and hour (lower byte) of the error occurrence date and time in BCD code.
GS224			Stores the minute (upper byte) and second (lower byte) of the error occurrence date and time in BCD code.
GS225		Request source	Stores the lower part of the IP address of the GOT (server function) where the error occurred in BIN code.
GS226			Stores the upper part of the IP address of the GOT (server function) where the error occurred in BIN code.
GS227 to GS229		Reserved	—

(2) GOT read information

Device	Function	Description
GS400	Gateway common control	Refer to (b) given below.

(a) Gateway common information (GS200)

b15	b14	b13 to b12	b11	b10 to b5	b4	b3	b2	b1	b0
-----	-----	------------	-----	-----------	----	----	----	----	----

- b0 : ON while the mail send function is ready.
- b1 : ON while the FTP server function is ready.
- b2 : Turns ON when the FTP client logs in.
- b3 : ON while the server function is ready.
- b4 : ON while the client function is ready.
- b5 to b10 : Reserved
- b11 : Turns ON when an error occurs in the mail send function.
- b12 to b13 : Reserved
- b14 : Turns ON when an error occurs in the server function.
- b15 : Turns ON when an error occurs in the client function.

(b) Gateway common control (GS400)

b15	b14	b13 to b12	b11	b10 to b3	b2	b1 to b0
-----	-----	------------	-----	-----------	----	----------

- b0 to b1 : Fixed at OFF.
- b2 : Turns ON to cause forced logout in the FTP server function.
- b3 to b10 : Fixed at OFF.
- b11 : Turns ON to clear the error of the mail send function (GS200.b11, GS201 to GS206).
- b12 to b13 : Fixed at OFF.
- b14 : Turns ON to clear the error of the server function (GS200.b14, GS210, GS211).
- b15 : Turns ON to clear the error of the client function (GS200.b15, GS220, GS221).

8.3 Server and Client Functions

8.3.1 Error codes and error messages

1 GOT error code list

The following table lists the error codes that are stored into the GOT special registers GS211 (server function error code) and GS221 (client function error code).

Error Code	Definition and Cause	Corrective Action
490	An attempt was made to monitor the gateway device of the GOT itself using the script function.	1. Set the other GOT as the monitor destination in the script. 2. Do not use the script but directly monitor the PLC devices.
491	An attempt was made to access a non-existing station.	Check the network number, PLC station number and Ethernet settings of the monitor destination.
492	A communication time error occurred.	1. Increase the "send time-out" period in the utility menu of the GOT. 2. Check the network. (Check firewall presence/absence, execute Ping, for example.)
493	A communication error occurred.	1. Check for cable disconnection and check the module mounting status. 2. Check the network. (Check firewall presence/absence, execute Ping, for example.)

* The error that will occur in the GOT of the server function is the error code 493 only.



- (1) If error code 493 occurs in GOT of server function

This error may occur when networks coexist.

If no error has occurred on the target client side, it poses no specific problem since communication is restored to normal by the retry processing on the client side.

- (2) System that uses a router

If the error code 493 occurred in the GOT of the server function, note that the IP address of the target client is the address of the router.

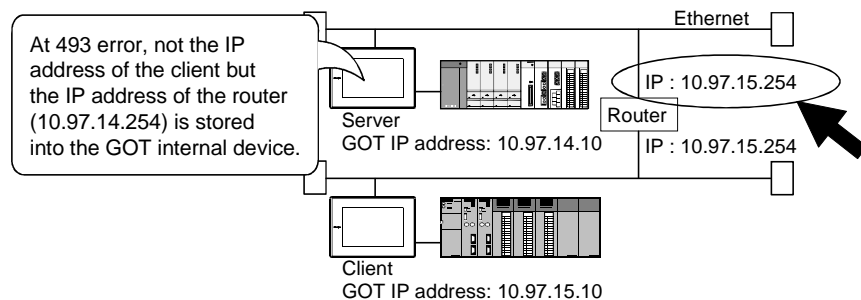

- (3) If an error occurs in the GOT with client function.

If an error occurs in the GOT with client function, the script will stop.

Take the corrective action and then re-execute the script.

Refer to the following manual for details of "Script function".



GT Works Version5/GT Designer Version5 Reference Manual

- (4) If error code 492 occurs in GOT of client function

This error may occur when there are many clients that access the server.

To increase the "send time-out period", set the value of "already set send time-out period×number of clients".

- (5) If error code 15 (script was not terminated after elapse of script watching time) was stored into the script error data (GS16 to GS47) when script that used gateway devices was used

This error may occur when there are many clients that access the server.



To increase the script watching time (GS385), set the value of "already set script watching time×number of clients".

Refer to the following manual for details of the script function.

 GT Works Version5/GT Designer Version5 Reference Manual

2 MX Component error code list

The following table lists the error codes that may occur when access is made from MX Component to the GOT.

Error Code	Definition and Cause	Corrective Action
0×0180840B	Time-out error Time-out period elapsed but data could not be received.	1. Corrective action for MX Component <ul style="list-style-type: none"> • Reexamine the time-out value in Properties. • Make the communication setting again in the communication setting utility. • Reexamine the PLC CPU, module setting, cable status and others. • Exit from MX Component once and execute it again. • Exit from the program and restart the DOS/V personal computer. ( MX Component Programming Manual) 2. Corrective action for GOT <ul style="list-style-type: none"> • Check whether the server setting of GT Designer has been made or not. ( Section 5.3)
	The used A9GT-J71E71-T is not compatible with the gateway functions.	Use the A9GT-J71E71-T that is compatible with the gateway functions. ( Section 2.3)
0×010F4030	An unusable device or non-existing device has been assigned to the accessed gateway device.	In the server setting of GT Designer, check whether device assignment is correct or the set device exists.
0×010F4031	The PLC device outside the monitor range has been assigned to the accessed gateway device.	In the server setting of GT Designer, check whether the device within the monitor range has been assigned.
0×010F4B00	Communication time-out occurred. Module or cable is not loaded properly.	1. Check for cable disconnection and check the communication board/communication module mounting status and PLC status. 2. This error may occur if the PLC load increases at other station access. At that time, move the other station data to the host PLC and monitor them on the host. 3. If the sequence scan is long, insert the COM instruction. 4. Check the GOT error codes of the alarm list display function (system alarm) and system information. If an error has occurred, take the corresponding corrective action. * 1

*1 About the GOT error codes

Refer to the following manuals for details of the GOT error codes.

-  • A985GOT/A975GOT/A970GOT/A960GOT User's Manual
- A950GOT/A951GOT/A953GOT/A956GOT User's Manual

8.3.2 Troubleshooting

The following table indicates the troubleshooting for use of the server and client functions.

Phenomenon	Definition and Cause	Corrective Action
Gateway device cannot be monitored.	A non-existing device is monitored in the server setting.	Check the PLC CPU device assigned to the gateway device.
	The IP address of the GOT to be monitored is wrong in the client setting.	Check the IP address of the GOT to be monitored.
	An error occurs in the GOT with server function or client function.	Confirm the GOT special register GS211 and GS221, and then take the corrective action. (☞ Section 8.2.1 Error code/Error message)
	The script function error occurs.	Confirm the script function error and then take the corrective action. (☞ GT Works Version5/GT Designer Version5 Reference Manual)

8.4 FTP Server Function

8.4.1 Error codes and error messages

The error codes and error messages related to the FTP server function are displayed on the FTP client side.

The error displaying method changes depending on the used FTP client tool.

The following tables indicate the errors that the GOT sends to the FTP client.

1 Normal codes and messages

code	message	Description
125	Data Connection already open; transfer starting	Transfer is started.
150	Opening connection	Connection for transfer is established.
200	Command okay.	Command is normal.
	Command successful.	
	PORT command successful.	PORT command succeeded.
214	The following commands are recognized.	Supported command list
	Help end.	HELP display ends.
	Syntax: <command name>	HELP display of corresponding command
220	GOT900 FTP server ready.	Connection is established.
221	User logged out. Good-Bye.	Connection ends.
226	Closing data connection.	Connection for transfer ends.
230	User logged in.	Login succeeded.
250	CWD command successful.	CWD (current directory change) command succeeded.
257	"A:* * * * */ * * * */ * * * ." is current directory.	Current directory display
275	MKD command successful.	MKD (directory creation) command succeeded.
331	Password required.	Password is required.

2 Abnormal codes and messages

Error code	Error message	Description
426	Connection closed; transfer aborted.	Transfer error
500	Syntax error, command unrecognized.	Syntax error, command cannot be recognized.
510	Command not supported.	Unsupported command
	Port open fails.	Port open failed.
	File open fails.	File open failed.
530	Not logged in.	Login failed.
550	Requested action not taken.	Command execution failed.

8.4.2 Troubleshooting

The following table indicates the troubleshooting for use of the FTP server function.

Phenomenon	Definition and Cause	Corrective Action
Line cannot be connected.	[Use FTP server function] is not checked in the FTP server setting of GT Designer.	Check [Use FTP server function].
	The other device has logged in to the GOT.	After the other device has logged in, connect to the line again.
	—	Issue the Ping command to the GOT and check for a reply.
	—	Ask the manager for confirmation.
Login cannot be made.	The login name or password is wrong.	Enter the correct login name or password. (Case sensitive)
File cannot be written.	The file name is 9 or more characters long.	Reduce the file name to "8 characters" + "." + "extension".
	The reference mode is selected.	Change to the write mode.
	Overwrite disable or similar setting has been made in the FTP client setting.	Reexamine the FTP client setting.
	The file of the same name exists.	Delete the file or change the file name so that the file of the same name does not exist.
	The PC card is write-protected.	Cancel the write protection of the PC card.
	The memory card access switch of the GOT is OFF.	Turn ON the memory card access switch of the GOT.
File cannot be read.	An attempt was made to read the file that does not exist.	Check for the file using the dir or ls command.
	The memory card access switch of the GOT is OFF.	Turn ON the memory card access switch of the GOT.
File cannot be deleted.	The PC card is write-protected.	Cancel the write protection of the PC card.
	The memory card access switch of the GOT is OFF.	Turn ON the memory card access switch of the GOT.
GOT was powered off during login.	—	Since the file being transferred may have been corrupted, do not use but delete it. (The operation of the FTP client changes depending on the specifications of the FTP client.)
FTP client software was forcibly exited during login.	—	Log in to the GOT again after the time set to the watching timer of command input in the FTP server setting has elapsed. (The GOT logs out after the time set to the command has elapsed.)

8.5 Mail Send Function

8.5.1 Error codes and error messages

The following table indicates the error codes stored into the GOT special register GS202 (mail send function error code).

Error Code	Definition and Cause	Corrective Action
2	The FROM address has not been set.	Set FROM. (Mail send setting on GT Designer)
3	The SMTP server has not been set.	Set the SMTP server. (Mail send setting on GT Designer)
4	The send destination address has not been set.	Set the send destination (TO). (Mail send setting on GT Designer)
5	The mail address is incorrect.	Check whether the mail address settings of FROM, TO, CC and BCC are correct. (Mail send setting on GT Designer)
6	The number of alarms that occurred may be greater than the number of alarms that can be sent by mail.	Check the number of alarms that occurred. (Max. number of queuing alarms: 16)
10	The SMTP server could not be connected.	<ol style="list-style-type: none"> 1. Check whether the SMTP server is normal or not. 2. Check whether the IP address setting of the SMTP server is correct or not. (Mail send setting on GT Designer) 3. Ask the network manager about the router address and sub-net mask and set the returned data in the setup of the GOT. 4. When a firewall has been built on the network, ask the network manager if it has been set to pass through the port 25.
11	Time-out occurred at the time of connection with the SMTP server.	<ol style="list-style-type: none"> 1. Check whether the SMTP server is normal or not. 2. Increase the send message time value. (Setup screen of GOT)
12	Error notification is given from the SMTP server.	<ol style="list-style-type: none"> 1. Check whether the SMTP server is normal or not. 2. Ask the network manager if mail can be sent without certification. (e.g. POP3 certification)

8.5.2 Troubleshooting

The following table indicates the troubleshooting for use of the mail send function.

Phenomenon	Definition and Cause	Corrective Action
Mail is not sent.	The SMTP server does not operate properly.	Ask the network manager if the SMTP server is operating properly.
	FROM of the send source is not set correctly.	Check whether FROM of the send source is set correctly.
	An attempt was made to send 17 or more mails at one time.	Reduce the number of mails to be sent simultaneously to 16 or less.
Time of sent mail is incorrect.	The time of the SMTP server is wrong. (The GOT sends mail at the time of the SMTP server.)	Check whether the time of the SMTP server is precise or not.
Sentence of mail sent (received) by cellular phone is broken midway.	The number of characters that can be sent (received) by the cellular phone was exceeded.	Reduce the number of characters in the sentence sent by mail to within the number of characters that can be sent (received) by the corresponding cellular phone.

INDEX

- [A]
 - About system programs 2- 4
 - Access range
 - FTP server function 6- 2
 - Mail send function..... 7- 2
 - Server and client functions..... 5- 9
- [C]
 - Checking the line connection condition 6- 6
 - Client setting 5-11
 - Connection form 2- 1
- [E]
 - Error codes and error messages
 - FTP server function 8- 7
 - Mail send function..... 8- 9
 - Server and client functions..... 8- 4
 - Example of use
 - FTP server function 6- 8
 - Mail send function..... 7- 6
 - Server and client functions..... 5-12
- [F]
 - Features of FTP server function 1- 3
 - Features of mail send function..... 1- 3
 - Features of server and client functions 1- 1
 - File specifying method 6- 5
 - FTP server setting 6- 3
 - Function setting 4- 1
- [G]
 - Gateway information 8- 2
 - GOT setting 4- 3
 - GT Designer setting 4- 4
- [H]
 - How to monitor the gateway devices..... 5- 3
- [I]
 - Input command on FTP client side 6- 4
- [L]
 - Line cutoff 6- 7

- [M]
 - Mail send enabled range 7- 2
 - Mail send setting 7- 3
- [O]
 - Operation on FTP client side 6- 4
 - Operation sequence 3- 1
- [P]
 - PLC devices that can be assigned..... 5- 6
 - Precautions
 - FTP server function..... 6-12
 - Mail send function 7- 8
 - Server and client functions 5-17
 - Precautions for mounting the
 - Communication board 2- 2
- [R]
 - Required devices 2- 2
- [S]
 - Server setting 5-10
 - Setting method
 - FTP server function..... 6- 3
 - Mail send function 7- 3
 - Server and client functions 5-10
 - Specifications
 - FTP server function..... 6- 1
 - Mail send function 7- 6
 - Server and client functions 5- 8
 - System configuration 2- 1
 - System configuration of gateway functions ... 2- 1
- [T]
 - Troubleshooting
 - FTP server function..... 8- 8
 - Mail send function 8- 9
 - Server and client functions 8- 6
- [W]
 - What is gateway device 5- 1
 - When using the bus connection board..... 2- 3
 - When using the serial communication board. 2- 2

WARRANTY

Please confirm the following product warranty details before starting use.

1. Gratis Warranty Term and Gratis Warranty Range

If any faults or defects (hereinafter "Failure") found to be the responsibility of Mitsubishi occurs during use of the product within the gratis warranty term, the product shall be repaired at no cost via the dealer or Mitsubishi Service Company. Note that if repairs are required at a site overseas, on a detached island or remote place, expenses to dispatch an engineer shall be charged for.

[Gratis Warranty Term]

The gratis warranty term of the product shall be for one year after the date of purchase or delivery to a designated place.

Note that after manufacture and shipment from Mitsubishi, the maximum distribution period shall be six (6) months, and the longest gratis warranty term after manufacturing shall be eighteen (18) months. The gratis warranty term of repair parts shall not exceed the gratis warranty term before repairs.

[Gratis Warranty Range]

- (1) The range shall be limited to normal use within the usage state, usage methods and usage environment, etc., which follow the conditions and precautions, etc., given in the instruction manual, user's manual and caution labels on the product.
- (2) Even within the gratis warranty term, repairs shall be charged for in the following cases.
 1. Failure occurring from inappropriate storage or handling, carelessness or negligence by the user. Failure caused by the user's hardware or software design.
 2. Failure caused by unapproved modifications, etc., to the product by the user.
 3. When the Mitsubishi product is assembled into a user's device, Failure that could have been avoided if functions or structures, judged as necessary in the legal safety measures the user's device is subject to or as necessary by industry standards, had been provided.
 4. Failure that could have been avoided if consumable parts (battery, backlight, fuse, etc.) designated in the instruction manual had been correctly serviced or replaced.
 5. Failure caused by external irresistible forces such as fires or abnormal voltages, and Failure caused by force majeure such as earthquakes, lightning, wind and water damage.
 6. Failure caused by reasons unpredictable by scientific technology standards at time of shipment from Mitsubishi.
 7. Any other failure found not to be the responsibility of Mitsubishi or the user.

2. Onerous repair term after discontinuation of production

- (1) Mitsubishi shall accept onerous product repairs for seven (7) years after production of the product is discontinued. Discontinuation of production shall be notified with Mitsubishi Technical Bulletins, etc.
- (2) Product supply (including repair parts) is not possible after production is discontinued.

3. Overseas service

Overseas, repairs shall be accepted by Mitsubishi's local overseas FA Center. Note that the repair conditions at each FA Center may differ.

4. Exclusion of chance loss and secondary loss from warranty liability

Regardless of the gratis warranty term, Mitsubishi shall not be liable for compensation to damages caused by any cause found not to be the responsibility of Mitsubishi, chance losses, lost profits incurred to the user by Failures of Mitsubishi products, damages and secondary damages caused from special reasons regardless of Mitsubishi's expectations, compensation for accidents, and compensation for damages to products other than Mitsubishi products and other duties.

5. Changes in product specifications

The specifications given in the catalogs, manuals or technical documents are subject to change without prior notice.

6. Product application

- (1) In using the Mitsubishi MELSEC programmable logic controller, the usage conditions shall be that the application will not lead to a major accident even if any problem or fault should occur in the programmable logic controller device, and that backup and fail-safe functions are systematically provided outside of the device for any problem or fault.
- (2) The Mitsubishi general-purpose programmable logic controller has been designed and manufactured for applications in general industries, etc. Thus, applications in which the public could be affected such as in nuclear power plants and other power plants operated by respective power companies, and applications in which a special quality assurance system is required, such as for Railway companies or National Defense purposes shall be excluded from the programmable logic controller applications.

Note that even with these applications, if the user approves that the application is to be limited and a special quality is not required, application shall be possible.

When considering use in aircraft, medical applications, railways, incineration and fuel devices, manned transport devices, equipment for recreation and amusement, and safety devices, in which human life or assets could be greatly affected and for which a particularly high reliability is required in terms of safety and control system, please consult with Mitsubishi and discuss the required specifications.

Microsoft Windows, Microsoft Windows NT are registered trademarks of Microsoft Corporation in the United States and other countries.

Pentium is a registered trademark of Intel Corporation in the United States and other countries.

Other company and product names herein are either trademarks or registered trademarks of their respective owners.

SPREAD

Copyright (C) 1998 Farpoint Technologies, Inc.

GOT-A900 Series Operating Manual

(GT Works Version5/GT Designer Version5 compatible
Gateway Functions Manual)

MODEL	SW1-GTD2-O(GAT)-E
MODEL CODE	1DM212
SH(NA)-080254-C(0406)MEE	

 **MITSUBISHI ELECTRIC CORPORATION**

HEAD OFFICE : 1-8-12, OFFICE TOWER Z 14F HARUMI CHUO-KU 104-6212, JAPAN
NAGOYA WORKS : 1-14, YADA-MINAMI 5-CHOME, HIGASHI-KU, NAGOYA, JAPAN

When exported from Japan, this manual does not require application to the
Ministry of Economy, Trade and Industry for service transaction permission.

Specifications subject to change without notice.